

2.7

FRAISAGE FREZEN



STEMATOOLS

QUALITY TOOLS FOR PROFESSIONALS

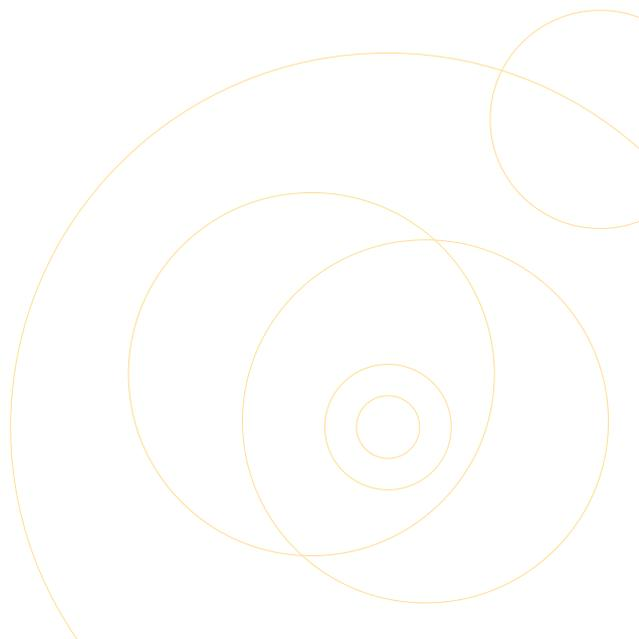
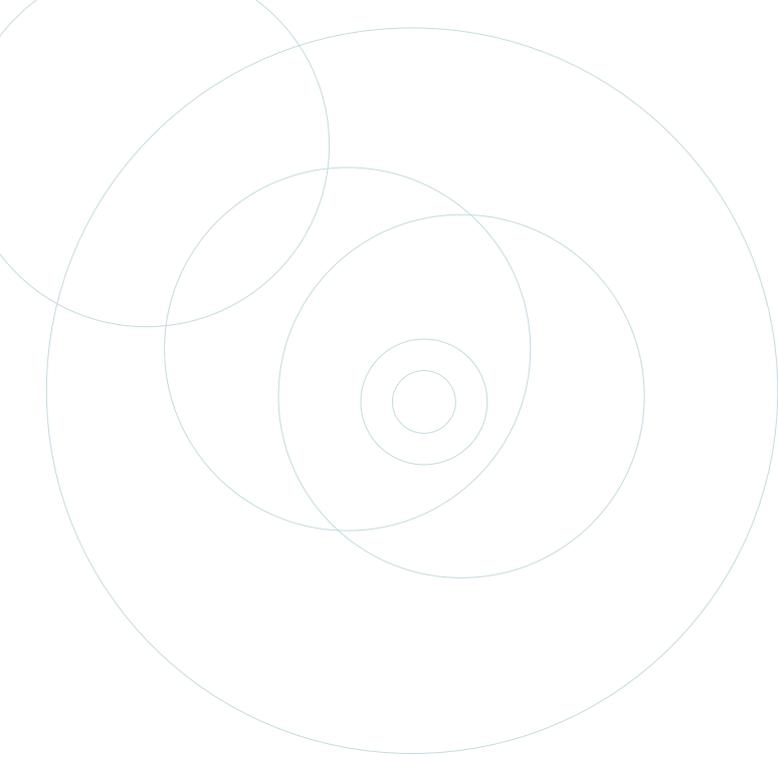

INDEX

FRAISES A SURFACER / FACE MILLING TOOLS	4-6
FRAISES A DRESSER / SQUARE SHOULDER MILLING TOOLS	7-9
FRAISES A SURFACER ET A COPIER - EBAUCHE MULTI PURPOSE MILLING TOOLS - ROUGHING	10-15
FRAISES MODULAIRES A RAINURER / MODULAR MILLING TOOLS	16-23
FRAISES A COPIER / END MILL TOOLS	24-27
FRAISES MODULAIRES EN CARBURE SOLID CARBIDE - MODULAR MILLING HEADS	28-30
RALLONGES / SHANK EXTENSIONS	31-33
FRAISES DIAMANTEES - PLAQUETTES PCD ET CBN ULTRA HARD SOLUTIONS	34-35
PIECES DE RECHANGE - ACCESSOIRES SPARE PARTS - ACCESSORIES	36
NUANCE FRAISAGE / MILLING GRADES	37
PARAMETRES DE COUPE RECOMMANDES RECOMMENDED CUTTING SPEEDS (m/min)	38
AVANCE ET PROFONDEUR DE PASSE RECOMMANDEES RECOMMENDED FEEDS AND DEPTH OF CUT	39

FRAISES A SURFACER / FACE MILLING TOOLS

C00036 | C00066

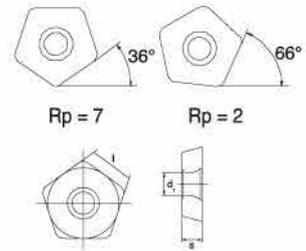
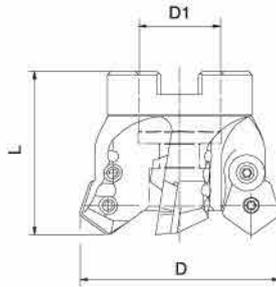

Order Code	REF.	Dimensions Dimensões Dimensiones						Spare parts Acessórios Accesorios			Insert Pastilha Placuita	Stock
		α	D	D1	L	Z	lxS					
241010500	066C00066-05-08	66°	66	27	55	5	12x4,76	H0140700	P0451200	XT20	PD... 120420 T	
241014700	080C00066-06-08	66°	80	27	55	6	12x4,76	H0140700	P0451200	XT20	PD... 120420 T	
241009800	066C00036-05-08	36°	66	27	55	5	12x4,76	H0140700	P0451200	XT20	PD... 120420 T	
241010400	080C00036-06-08	36°	80	27	55	6	12x4,76	H0140700	P0451200	XT20	PD... 120420 T	
241018100	100C00036-07-08	36°	100	32	55	7	12x4,76	H0140700	P0451200	XT20	PD... 120420 T	
241001100	125C00036-08-08	36°	125	40	55	8	12x4,76	H0140700	P0451200	XT20	PD... 120420 T	
241002700	160C00036-09-08	36°	160	40	55	9	12x4,76	H0140700	P0451200	XT20	PD... 120420 T	

PDMW | PDHW

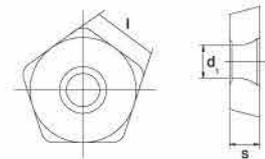
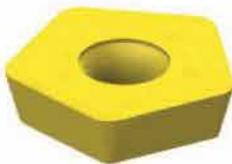

		GRADES Graus Grados																						
		P					M				K				N		S		H					
		CC	CC	CC	CC	CC	CC	CC	CC	CC	CC	CC	UC	CC	UC	CC	CC	CC	CC	CC	Dimensiones Dimensões Dimensiones			
		(1) Grade Code																						
		86	78	54	64	68	86	78	67	68	67	54	10	68	10	D6	78	68	64	D4	S	I	R	d1
(1) Geometry Code	ISO	PH6135	PH6125	PH6910	PH6903	PH6920	PH6135	PH6125	PH6315	PH6920	PH6315	PH6910	PH0910	PH6920	PH0310	PDJP410	PH6125	PH6920	PH6903	PBH910				
1110555	PDMW 12 04 20 T																				4,76	12,00	2,00	5,20
1110554	PDHW 12 04 20 T																				4,76	12,00	2,00	5,20
1110927	PDHW 12 04 20 SP																				4,76	12,00	2,00	5,20

Stock items / Itens de stock Available under request / Disponibilidade sob consulta / Disponible bajo consulta

(1) Insert Order Code = Geometry Code + Grade Code

FRAISES A SURFACER / FACE MILLING TOOLS

B55043

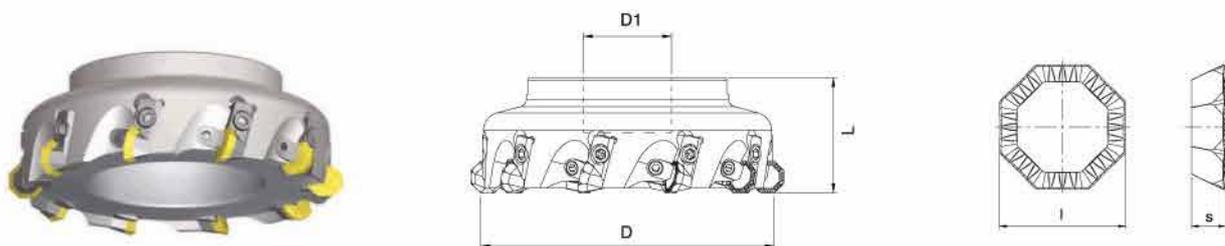

Order Code	REF.	Dimensions Dimensões Dimensiones					Spare parts Acessórios Accesorios				Insert Pastilha Plaquita	Stock
		D	D1	L	Z	IxS						
241019300	063B55043-04-15	63	22	40	4	17,94x4,72	-	NJ B55043	XU04	XU05	OF... 070405	
241019400	080B55043-05-15	80	27	50	5	17,94x4,72	-	NJ B55043	XU04	XU05	OF... 070405	
241032700	100B55043-06-15	100	32	50	6	17,94x4,72	-	NJ B55043	XU04	XU05	OF... 070405	
241019500	125B55043-08-15	125	40	63	8	17,94x4,72	-	NJ B55043	XU04	XU05	OF... 070405	
241032800	160B55043-10-15	160	40	63	10	17,94x4,72	PK B55043	NJ B55043	XU04	XU05	OF... 070405	

OFKN | OFKR



		GRADES Grupos Grados																					
		P				M				K				N		S		H					
		CC	CC	CC	CC	CC	CC	CC	CC	CC	CC	UC	CC	UC	CC	CC	CC	CC	CC	CC	Dimensions Dimensões Dimensiones		
		(1) Grade Code																					
(1) Geometry Code	ISO	PH6135	PH6125	PH6910	PH6903	PH6920	PH6135	PH6125	PH6315	PH6920	PH6315	PH6910	PH6910	PH6920	PH0310	PDP410	PH6125	PH6920	PH6903	PBH610	S	I	R
1111158	OFKR 070405 TN-A1																				4,72	17,94	0,7
1111147	OFKN 070405 TN-A2																				4,72	17,94	0,7
1111148	OFKN 070405 FN-A2																				4,72	17,94	0,7

Stock items / Itens de stock Available under request / Disponibilidade sob consulta / Disponible bajo consulta

(1) Insert Order Code = Geometry Code + Grade Code

FRAISES A SURFACER / FACE MILLING TOOLS

A09945

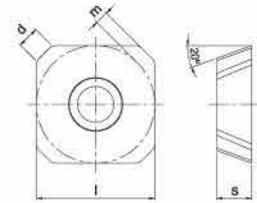
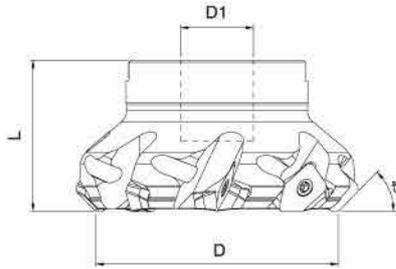

Order Code	REF.	Dimensões Dimensiones Dimensiones						Spare parts Acessórios Accesorios				Insert Pastilla Placilla	Stock
		α	D	D1	L	Z	lxS						
181034700	050A09945-04-21	45°	50	22	40	4	13,37x3,97	P0351200	T0503509	CS1103	XT15	SEHT 13T3...	
181024200	063A09945-05-21	45°	63	27	40	5	13,37x3,97	P0351200	T0503509	CS1103	XT15	SEHT 13T3...	
181024300	080A09945-06-21	45°	80	27	50	6	13,37x3,97	P0351200	T0503509	CS1103	XT15	SEHT 13T3...	
181024400	100A09945-07-21	45°	100	32	50	7	13,37x3,97	P0351200	T0503509	CS1103	XT15	SEHT 13T3...	
181024500	125A09945-08-21	45°	125	40	63	8	13,37x3,97	P0351200	T0503509	CS1103	XT15	SEHT 13T3...	
181024600	160A09945-10-21	45°	160	40	63	10	13,37x3,97	P0351200	T0503509	CS1103	XT15	SEHT 13T3...	

*Other Dimensions available under request.

SEHT

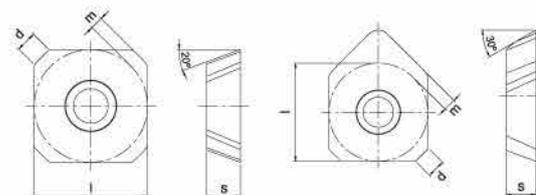

		GRADES Grupos Grados																						
		P				M				K				N		S		H						
		CC	CC	CC	CC	CC	CC	CC	CC	CC	CC	UC	CC	UC	CC	CC	CC	CC	CC	Dimensiones Dimensiones Dimensiones				
		(1) Grade Code																						
		86	78	54	64	68	86	78	67	68	67	54	10	68	10	D6	78	68	64	D4				
		(1) Geometry Code																						
		PH6135	PH6125	PH6910	PH6903	PH6920	PH6135	PH6125	PH6315	PH6920	PH6315	PH6910	PH0910	PH6920	PH0310	PDP410	PH6125	PH6920	PH6903	PBH910	s	l	d	m
1110559	SEHT 13T3 AGSN																				3,97	13,37	2,51	1,52
1110931	SEHT 13T3 AGTN																				3,97	13,37	2,51	1,52
1111146	SEHW 13T3 AGFN																				3,97	13,37	2,51	1,52
1110627	SEHT 13T3 AGSN-W																				3,97	13,37	2,51	1,52

Stock items / Itens de stock Available under request / Disponibilidade sob consulta / Disponible bajo consulta.

(1) Insert Order Code = Geometry Code + Grade Code

FRAISES A DRESSER / SQUARE SHOULDER MILLING TOOLS

A17090

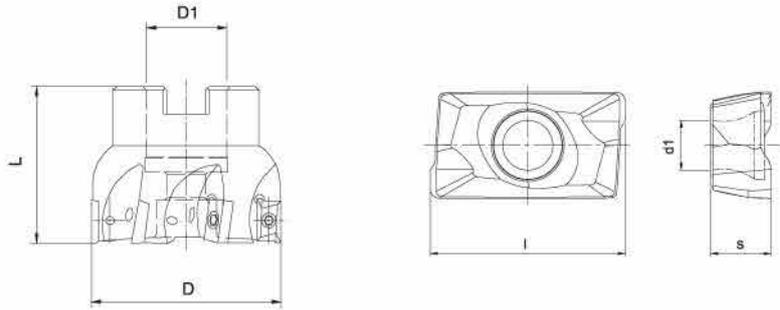

Order Code	REF.	Dimensions Dimensões Dimensiones						Spare parts Acessórios Accesorios		Insert Pastilha Plaquita	Stock
		α	D	D1	L	Z	I x S				
241010200	040A17090-06-05	90°	40	16	40	6	11,30x3,65	P0250700	XT07	APKT 1003...	
241010300	050A17090-07-05	90°	50	22	50	7	11,30x3,65	P0250700	XT07	APKT 1003...	
241014300	063A17090-08-05	90°	63	27	50	8	11,30x3,65	P0250700	XT07	APKT 1003...	

APKT 1003

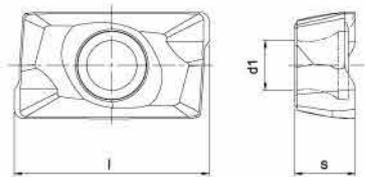
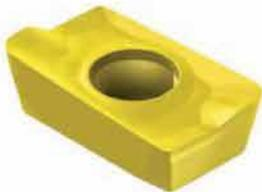

		GRADES Grupos Grupos																							
		P				M				K				N		S		H							
		CC	CC	CC	CC	CC	CC	CC	CC	CC	CC	UC	CC	UC	CC	CC	CC	CC	CC	CC	Dimensions Dimensões Dimensiones				
		86	78	54	64	68	86	78	67	68	67	54	10	68	10	D6	78	68	64	D4					
(1) Geometry Code	ISO	PH6135	PH6125	PH6910	PH6903	PH6920	PH6135	PH6125	PH6315	PH6920	PH6315	PH6910	PH0910	PH6920	PH0310	PDP410	PH6125	PH6920	PH6903	PBH910	d	s	I	R	d1
1111040	APKT 100305 PDFR-X																				6,67	3,65	11,30	0,5	2,80
1111070	APKT 100305 PDER-X																				6,67	3,65	11,30	0,5	2,80
1110946	APKT 100305 PDTR-X																				6,67	3,65	11,30	0,5	2,80
1111041	APKT 100305 PDSR-X																				6,67	3,65	11,30	0,5	2,80
1111043	APKT 100308 PDFR-X																				6,67	3,65	11,30	0,8	2,80
1111071	APKT 100308 PDER-X																				6,67	3,65	11,30	0,8	2,80
1111042	APKT 100308 PDTR-X																				6,67	3,65	11,30	0,8	2,80
1111044	APKT 100308 PDSR-X																				6,67	3,65	11,30	0,8	2,80
1111046	APKT 100312 PDFR-X																				6,67	3,65	11,30	1,2	2,80
1111072	APKT 100312 PDER-X																				6,67	3,65	11,30	1,2	2,80
1111045	APKT 100312 PDTR-X																				6,67	3,65	11,30	1,2	2,80
1110987	APKT 100312 PDSR-X																				6,67	3,65	11,30	1,2	2,80

Stock items / Itens de stock Available under request / Disponibilidade sob consulta / Disponible bajo consulta

(1) Insert Order Code = Geometry Code + Grade Code

FRAISES A DRESSER / SQUARE SHOULDER MILLING TOOLS

A18090

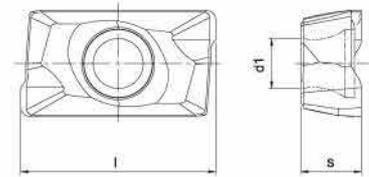
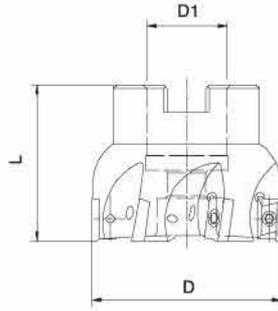

Order Code	REF.	Dimensiones Dimensões Dimensiones						Spare parts Acessórios Accesorios		Insert Poinón Poinóns	Stock
		α	D	D1	L	Z	l x S				
241031200	040A18090-04-07	90°	40	16	40	4	17,34x5,3	P0401100	XT15	APKT 1604...	
241030900	050A18090-05-07	90°	50	22	40	5	17,34x5,3	P0401100	XT15	APKT 1604...	
241031300	063A18090-06-07	90°	63	22	40	6	17,34x5,3	P0401100	XT15	APKT 1604...	
241031400	080A18090-07-07	90°	80	27	50	7	17,34x5,3	P0401100	XT15	APKT 1604...	
241031500	100A18090-08-07	90°	100	32	50	8	17,34x5,3	P0401100	XT15	APKT 1604...	
241031600	125A18090-09-07	90°	125	40	83	9	17,34x5,3	P0401100	XT15	APKT 1604...	

APKT 1604

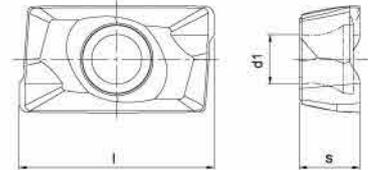

		GRADES Grãos Grados																							
		P					M				K			N		S		H							
		CC	CC	CC	CC	CC	CC	CC	CC	CC	CC	CC	UC	CC	UC	CC	CC	CC	CC	CC	Dimensiones Dimensões Dimensiones				
		(1) Grade Code																							
		86	78	54	64	68	86	78	67	68	67	54	10	68	10	D6	78	68	64	D4					
(1) Geometry Code	ISO	PH6135	PH6125	PH6910	PH6903	PH6920	PH6135	PH6125	PH6315	PH6920	PH6315	PH6910	PH6920	PH0310	PDP410	PH6125	PH6920	PH6903	PBH910						
																					d	s	l	R	d1
1111047	APKT 160408 PDFR-X			○		⊗				○	○	⊗					⊗			9,45	5,30	17,34	0,8	4,40	
1111073	APKT 160408 PDER-X	⊗	⊗	○		⊗	⊗	⊗		⊗	○	⊗					⊗	⊗		9,45	5,30	17,34	0,8	4,40	
1110937	APKT 160408 PDTR-X	⊗	⊗														⊗			9,45	5,30	17,34	0,8	4,40	
1111048	APKT 160408 PDSR-X	⊗	⊗														⊗			9,45	5,30	17,34	0,8	4,40	
1111049	APKT 160416 PDFR-X			○		⊗				○	○	⊗					⊗			9,45	5,30	17,34	1,6	4,40	
1111074	APKT 160416 PDER-X	⊗	⊗	○		⊗	⊗	⊗		⊗	○	⊗					⊗	⊗		9,45	5,30	17,34	1,6	4,40	
1110988	APKT 160416 PDTR-X	⊗	⊗														⊗			9,45	5,30	17,34	1,6	4,40	
1111050	APKT 160416 PDSR-X	⊗	⊗														⊗			9,45	5,30	17,34	1,6	4,40	
1110918	APKT 160432 PDFR-X			○		⊗				○	○	⊗					⊗			9,45	5,30	17,34	3,2	4,40	
1111075	APKT 160432 PDER-X	⊗	⊗	○		⊗	⊗	⊗		⊗	○	⊗					⊗	⊗		9,45	5,30	17,34	3,2	4,40	
1111051	APKT 160432 PDTR-X	⊗	⊗														⊗			9,45	5,30	17,34	3,2	4,40	
1111052	APKT 160432 PDSR-X	⊗	⊗														⊗			9,45	5,30	17,34	3,2	4,40	

⊗ Stock items / Itens de stock ○ Available under request / Disponibilidade sob consulta / Disponible bajo consulta

(1) Insert Order Code = Geometry Code + Grade Code

FRAISES A DRESSER / SQUARE SHOULDER MILLING TOOLS

A15090

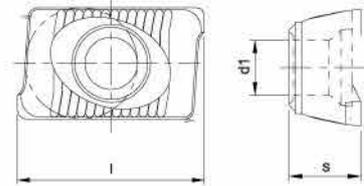
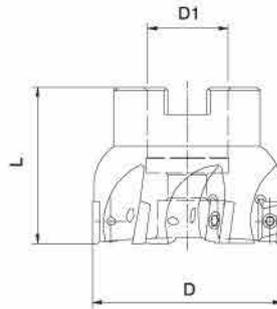

Order Code	REF.	Dimensions Dimensões Dimensiones						Spare parts Acessórios Accesorios		Insert Paçotes Paquetes	Stock
		α	D	D1	L	Z	I x S				
241014000	052A15090-05-07	90°	52	22	50	5	15,85x5,60	P0401100	XT15	ADKT 1505...	
241014100	066A15090-06-07	90°	66	27	50	6	15,85x5,60	P0401100	XT15	ADKT 1505...	
241010000	080A15090-07-07	90°	80	27	50	7	15,85x5,60	P0401100	XT15	ADKT 1505...	
241014200	100A15090-08-07	90°	100	32	50	8	15,85x5,60	P0401100	XT15	ADKT 1505...	
241033400	125A15090-09-07	90°	125	40	50	9	15,85x5,60	P0401100	XT15	ADKT 1505...	

ADKT 1505

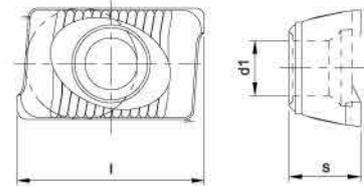

		GRADES Graus Grados																							
		P					M				K			N		S		H							
		CC	CC	CC	CC	CC	CC	CC	CC	CC	CC	CC	UC	CC	UC	CC	CC	CC	CC	CC	Dimensiones Dimensões Dimensiones				
		(1) Grade Code																							
		86	78	54	64	68	86	78	67	68	67	54	10	68	10	D6	78	68	64	D4	d	S	I	R	d1
(1) Geometry Code	ISO	PH6135	PH6125	PH6910	PH6903	PH6920	PH6135	PH6125	PH6315	PH6920	PH6315	PH6910	PH0810	PH6920	PH0310	PDP410	PH6125	PH6920	PH6903	PBH910					
1110611	ADKT 1505 PDFR																			9,53	5,60	15,85	0,8	4,40	
1110006	ADKT 1505 PDER																			9,53	5,60	15,85	0,8	4,40	
1111209	ADKT 1505 PDTR																			9,53	5,60	15,85	0,8	4,40	
1111218	ADKT 1505 PDSR																			9,53	5,60	15,85	0,8	4,40	

Stock items / Itens de stock Available under request / Disponibilidade sob consulta / Disponible bajo consulta

(1) Insert Order Code = Geometry Code + Grade Code

FRAISES A SURFACER ET A COPIER - EBAUCHE MULTI PURPOSE MILLING TOOLS - ROUGHING

A25090

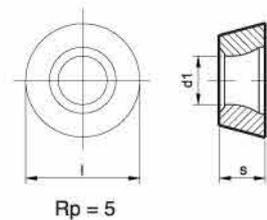
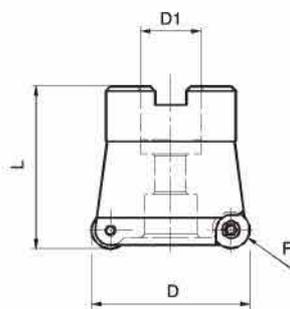

Order Code	REF.	Dimensions Dimensões Dimensiones						Spare parts Acessórios Accesorios			Insert Pastilha Plaquita	Stock
		Rp	D	D1	L	Z	lxS					
241010600	042A25090-06	5	42	16	44	6	10x3,18	P0350701	-	XT15	RD...1003MOT	
241017500	052A25090-07	5	52	22	50	7	10x3,18	P0350701	-	XT15	RD...1003MOT	

A25190 | C25290

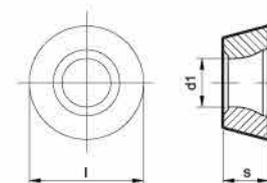
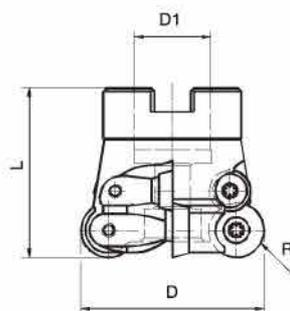

Order Code	REF.	Dimensions Dimensões Dimensiones						Spare parts Acessórios Accesorios				Insert Pastilha Plaquita	Stock
		Rp	D	D1	L	Z	lxS						
241010700	052A25190-05	6	52	22	50	5	12x3,97	-	P0300750	P0350800	XT15	RD...12T3MOT	
241016100	066A25190-06	6	66	27	50	6	12x3,97	-	P0300750	P0350800	XT15	RD...12T3MOT	
241016500	080A25190-07	6	80	27	50	7	12x3,97	-	P0300750	P0350800	XT15	RD...12T3MOT	
241017900	052C25290-04	8	52	22	50	4	16x4,76	H0140700	-	P0451001	XT20	RD...1604MOT	
241011000	066C25290-05	8	66	27	50	5	16x4,76	H0140700	-	P0451001	XT20	RD...1604MOT	
241016200	080C25290-06	8	80	27	52	6	16x4,76	H0140700	-	P0451001	XT20	RD...1604MOT	

Stock items / Itens de stock Available under request / Disponibilidade sob consulta / Disponible bajo consulta

FRAISES A SURFACER ET A COPIER - EBAUCHE MULTI PURPOSE MILLING TOOLS - ROUGHING

**A25191 | C25290
C25390**

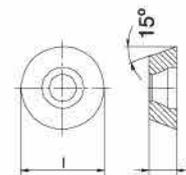
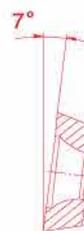
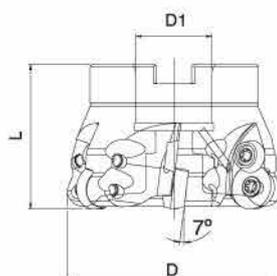

Order Code	REF.	Dimensions Dimensões Dimensiones						Spare parts Acessórios Accesorios				Insert Pastilha Placuito	Stock
		Rp	D	D1	L	Z	lxS						
241010800	052A25190-05-07	6	52	22	50	5	12x3,97	-	P0300750	P0350800	XT15	RD...12T3MOT	
241010900	066A25190-06-07	6	66	27	50	6	12x3,97	-	P0300750	P0350800	XT15	RD...12T3MOT	
241016600	080A25190-07-07	6	80	27	50	7	12x3,97	-	P0300750	P0350800	XT15	RD...12T3MOT	
241018000	052C25290-04-07	8	52	22	50	4	16x4,76	H0140700	-	P0451001	XT20	RD...1604MOT	
241016700	066C25290-05-07	8	66	27	50	5	16x4,76	H0140700	-	P0451001	XT20	RD...1604MOT	
241011100	080C25290-06-07	8	80	27	52	6	16x4,76	H0140700	-	P0451001	XT20	RD...1604MOT	
241017300	125C25290-08-07	8	125	40	52	8	16x4,76	H0140700	-	P0451001	XT20	RD...1604MOT	
241017400	160C25290-09-07	8	160	40	52	9	16x4,76	H0140700	-	P0451001	XT20	RD...1604MOT	
241026400	080C25390-05-07	10	80	27	50	5	20x6,35	H0140700	-	P0601400	XT20	RD...2006MOT	
241016800	100C25390-06-07	10	100	32	52	6	20x6,35	H0140700	-	P0601400	XT20	RD...2006MOT	
241020500	125C25390-07-07	10	125	40	52	7	20x6,35	H0140700	-	P0601400	XT20	RD...2006MOT	
241020600	160C25390-08-07	10	160	40	52	8	20x6,35	H0140700	-	P0601400	XT20	RD...2006MOT	

FRAISES A SURFACER ET A COPIER - EBAUCHE MULTI PURPOSE MILLING TOOLS - ROUGHING

**RDMW | RDHW
RDMT | RDHT**

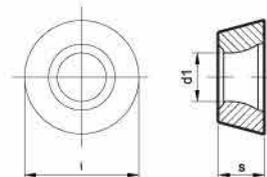
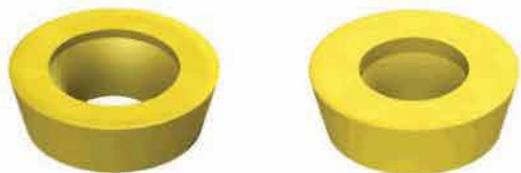

		GRADES Grados Grados																					
		P				M				K				N		S		H					
		CC	CC	CC	CC	CC	CC	CC	CC	CC	CC	UC	CC	UC	CC	CC	CC	CC	CC	Dimensions Dimensiones Dimensiones			
		(1) Grade Code																					
(1) Geometry Code	ISO	PH6135	PH6125	PH6910	PH6903	PH6920	PH6135	PH6125	PH6315	PH6920	PH6315	PH6910	PH0910	PH6920	PH0310	PDP410	PH6125	PH6920	PH6903	PBH810	l	s	d1
1110549	RDMW 1003 MOT	⊗	⊗				⊗	⊗									⊗				10	3,18	4,0
1110096	RDMW 12T3 MOT	⊗	⊗				⊗	⊗									⊗				12	3,97	4,0
1110097	RDMW 1604 MOT	⊗	⊗				⊗	⊗									⊗				16	4,76	5,2
1110869	RDMW 2006 MOT	⊗	⊗				⊗	⊗									⊗				20	6,35	6,5
1110087	RDHW 1003 MOT	⊗	⊗	○	⊗	⊗	⊗	⊗		⊗		○		⊗		⊗	⊗	⊗	⊗	⊗	10	3,18	4,0
1110090	RDHW 12T3 MOT	⊗	⊗	○	⊗	⊗	⊗	⊗		⊗		○		⊗		⊗	⊗	⊗	⊗	⊗	12	3,97	4,0
1110092	RDHW 1604 MOT	⊗	⊗	○	○	⊗	⊗	⊗		⊗		○		⊗		⊗	⊗	⊗	○	⊗	16	4,76	5,2
1111217	RDHW 2006 MOT	○	○	○	○	○	○	○				○		○			○	○			20	6,35	6,5
1110583	RDMT 1003 MOT	⊗	⊗				⊗	⊗									⊗				10	3,18	4,0
1110558	RDMT 12T3 MOT	⊗	⊗				⊗	⊗									⊗				12	3,97	4,0
1110556	RDMT 1604 MOT	⊗	⊗				⊗	⊗									⊗				16	4,76	5,2
1110859	RDMT 2006 MOT	⊗	⊗				⊗	⊗									⊗				20	6,35	6,5
1110082	RDHT 1003 MOT	⊗	⊗	○	○	○	⊗	⊗		○		○		○			⊗	○	○	○	10	3,18	4,0
1110083	RDHT 12T3 MOT	⊗	⊗	○	○	○	⊗	⊗		○		○		○			⊗	○	○	○	12	3,97	4,0
1110084	RDHT 1604 MOT	⊗	⊗	○	○	○	⊗	⊗		○		○		○			⊗	○	○	○	16	4,76	5,2
1110672	RDHT 2006 MOT	⊗	⊗	○	○	○	⊗	⊗		○		○		○			⊗	○	○	○	20	6,35	6,5

⊗ Stock items / Itens de stock ○ Available under request / Disponibilidade sob consulta / Disponible bajo consulta

(1) Insert Order Code = Geometry Code + Grade Code

FRAISES A SURFACER ET A COPIER - EBAUCHE MULTI PURPOSE MILLING TOOLS - ROUGHING

A50060

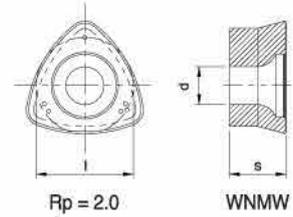
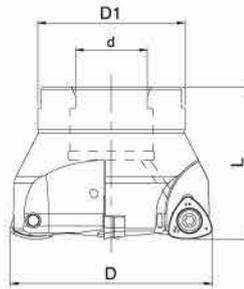

Order Code	REF.	Dimensions Dimensões Dimensiones						Spare parts Acessórios Accesorios		Insert Pastilha Plaquita	Stock
		Rp	D	D1	L	Z	lxS				
241020400	052A50060-03	2,0	52	22	44	3	12x7,00	P0451400	XT20	WNMW 1207-SP	
241033900	063A50060-04	2,0	63	27	50	4	12x7,00	P0451400	XT20	WNMW 1207-SP	
241028700	066A50060-04	2,0	66	27	50	4	12x7,00	P0451400	XT20	WNMW 1207-SP	
241035900	066A50060-05	2,0	66	27	50	5	12x7,00	P0451400	XT20	WNMW 1207-SP	
241020100	080A50060-05	2,0	80	27	50	5	12x7,00	P0451400	XT20	WNMW 1207-SP	

WNMW

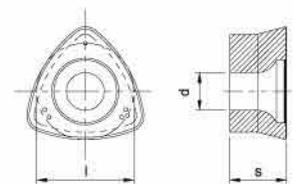

		GRADES Graus Grados																					
		P				M				K				N		S		H					
		CC	CC	CC	CC	CC	CC	CC	CC	CC	CC	UC	CC	UC	CC	CC	CC	CC	CC	Dimensione Dimensões Dimensiones			
(1) Grade Code		86	78	54	64	68	86	78	67	68	67	54	10	68	10	D6	78	68	64	D4	d	s	l
(1) Geometry Code	ISO	PH6135	PH6125	PH6910	PH6903	PH6920	PH6135	PH6125	PH6315	PH6920	PH6315	PH6910	PH6910	PH6920	PH0310	PDP410	PH6125	PH6920	PH6903	PEH910			
1121148	WNMW 1207-SP																				4,7	7	12

Stock items / Itens de stock Available under request / Disponibilidade sob consulta / Disponible bajo consulta

(1) Insert Order Code = Geometry Code + Grade Code

FRAISES A SURFACER ET A COPIER - EBAUCHE MULTI PURPOSE MILLING TOOLS - ROUGHING

A06690 | A06590

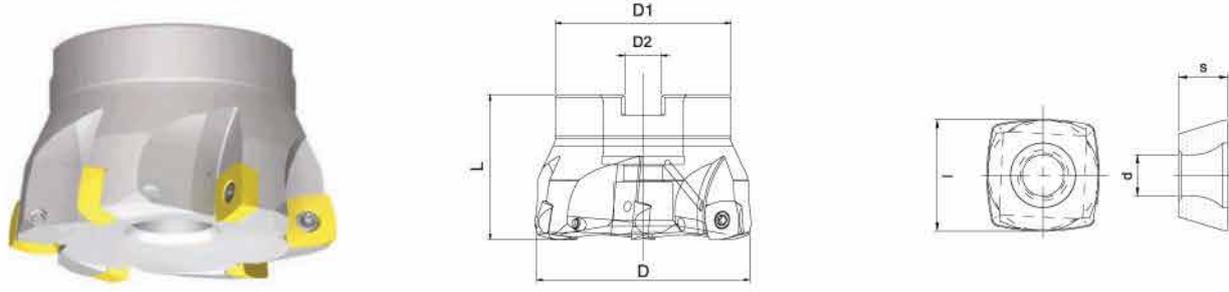

Order Code	REF.	Dimensions Dimensões Dimensiones							Spare parts Acessórios Accesorios		Insert Pastilla Plaquita	Stock
		Rp	D	D1	D2	L	Z	lxS				
241029800	052A06690-04-05	2,5	52	40	22	45	4	13x5,56	P0401300	XT15	SPKW / SPKT 130510	
241033500	063A06690-05-05	2,5	63	48	27	50	5	13x5,56	P0401300	XT15	SPKW / SPKT 130510	
241029900	066A06690-05-05	2,5	66	48	27	50	5	13x5,56	P0401300	XT15	SPKW / SPKT 130510	
241030000	080A06690-06-05	2,5	80	60	27	50	6	13x5,56	P0401300	XT15	SPKW / SPKT 130510	
241038000	052A06590-06-05	1,8	52	40	22	45	6	8,5x3,97	P0300800	XT09	SPKW / SPKT 08T308	

SPKW | SPKT

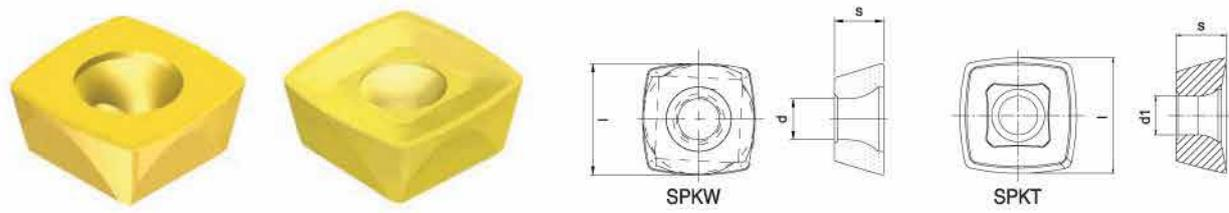

		GRADES Grupos Grados																					
		P				M				K				N		S		H					
		CC	CC	CC	CC	CC	CC	CC	CC	CC	CC	UC	CC	UC	CC	CC	CC	CC	CC	Dimensions Dimensões Dimensiones			
		86	78	54	64	68	86	78	67	68	67	54	10	68	10	D6	78	68	64	D4	d	s	l
(1) Geometry Code	ISO	PH6135	PH6125	PH6910	PH6903	PH6920	PH6135	PH6125	PH6315	PH6920	PH6315	PH6910	PH0910	PH6920	PH0310	PDP410	PH6125	PH6920	PH6903	PBH910			
1110888	SPKW 130510 S																				4,35	5,56	13,00
1111195	SPKT 130510																				4,35	5,56	13,00
1121227	SPKW 08T308 S																				3,4	3,97	8,5
1111314	SPKT 08T308																				3,4	3,97	8,5

Stock items / Itens de stock Available under request / Disponibilidade sob consulta / Disponible bajo consulta
(1) Insert Order Code = Geometry Code + Grade Code

FRAISES A SURFACER ET A COPIER - EBAUCHE MULTI PURPOSE MILLING TOOLS - ROUGHING

C40595

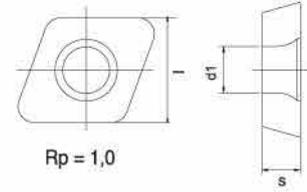
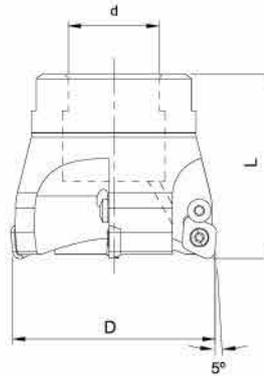

Order Code	REF.	Dimensions Dimensões Dimensiones							Spare parts Acessórios Accesorios			Insert Pastilha Plaquita	Stock
		α	Rp	D	d	L	Z	lxS					
241027700	052C40595-05-07	95°	1,0	52	22	50	5	10,0x3,97	P0350900	P0300750	XT15	XDHW 10T310	
241027800	066C40595-06-07	95°	1,0	66	27	50	6	10,0x3,97	P0350900	P0300750	XT15	XDHW 10T310	
241027900	080C40595-07-07	95°	1,0	80	27	50	7	10,0x3,97	P0350900	P0300750	XT15	XDHW 10T310	

XDHW

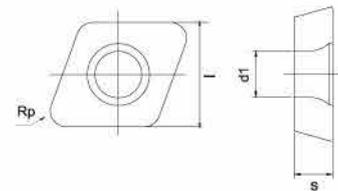

		GRADES Graus Grados																						
		P					M				K			N		S		H						
		CC	CC	CC	CC	CC	CC	CC	CC	CC	CC	CC	UC	CC	UC	CC	CC	CC	CC	CC	Dimensional Dimensões Dimensiones			
		(1) Grade Code																						
		86	78	54	64	68	86	78	67	68	67	54	10	68	10	D6	78	68	64	D4				
		(1) Geometry Code																						
		ISO																						
		PH6135	PH6125	PH6910	PH6903	PH6920	PH6135	PH6125	PH6315	PH6920	PH6315	PH6910	PH0910	PH6920	PH0310	PDP410	PH6125	PH6920	PH6903	PBH910	S	I	R	d1
1110565	XDHW 10T310																				3,97	10,00	1,0	3,80

Stock items / Itens de stock Available under request / Disponibilidade sob consulta / Disponible bajo consulta

(1) Insert Order Code = Geometry Code + Grade Code

FRAISES MODULARES A RAINURER / MODULAR MILLING TOOLS

R17090

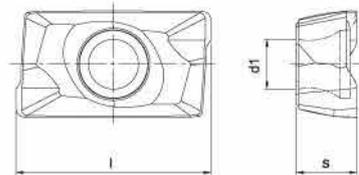
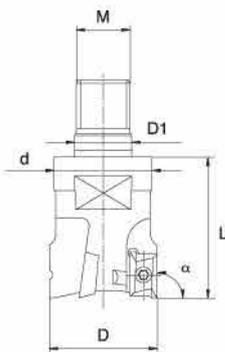

Order Code	REF.	Dimensiones Dimensões Dimensiones									Spare parts Acessórios Accessoires		Insert Pastilha Plaquita	Stock
		α	D	D1	L	d	Z	M	I x S					
241015100	016R17090-02-07-M08	90°	16	8,5	25	13,8	2	8	11,30x3,65	P0250700	XT07	APKT 1003...		
241015200	020R17090-03-07-M10	90°	20	10,5	30	18,0	3	10	11,30x3,65	P0250700	XT07	APKT 1003...		
241015300	025R17090-04-07-M12	90°	25	12,5	35	21,0	4	12	11,30x3,65	P0250700	XT07	APKT 1003...		

APKT 1003

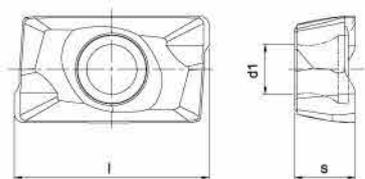

		GRADES Graus Grados																							
		P				M				K				N		S		H							
		CC	CC	CC	CC	CC	CC	CC	CC	CC	CC	UC	CC	UC	CC	CC	CC	CC	CC	Dimensiones Dimensões Dimensiones					
		86	78	54	64	68	86	78	67	68	67	54	10	68	10	D6	78	68	64	D4	d	s	i	R	d1
(1) Geometry Code	ISO	PH6135	PH6125	PH6910	PH6903	PH6920	PH6135	PH6125	PH6315	PH6920	PH6315	PH6910	PH0910	PH6920	PH0310	PDP410	PH6125	PH6920	PH6903	PBH910					
1111040	APKT 100305 PDFR-X			○		⊗			○	⊗	○	○		⊗				⊗			6,67	3,65	11,30	0,5	2,80
1111070	APKT 100305 PDER-X	⊗	⊗	○		⊗	⊗	⊗	⊗	⊗	○	○		⊗			⊗	⊗			6,67	3,65	11,30	0,5	2,80
1110946	APKT 100305 PDTR-X	⊗	⊗			⊗								⊗				⊗			6,67	3,65	11,30	0,5	2,80
1111041	APKT 100305 PDSR-X	⊗	⊗			⊗								⊗				⊗			6,67	3,65	11,30	0,5	2,80
1111043	APKT 100308 PDFR-X			○		⊗			○	⊗	○	○		⊗				⊗			6,67	3,65	11,30	0,8	2,80
1111071	APKT 100308 PDER-X	⊗	⊗	○		⊗	⊗	⊗	⊗	⊗	○	○		⊗			⊗	⊗			6,67	3,65	11,30	0,8	2,80
1111042	APKT 100308 PDTR-X	⊗	⊗			⊗								⊗				⊗			6,67	3,65	11,30	0,8	2,80
1111044	APKT 100308 PDSR-X	⊗	⊗			⊗								⊗				⊗			6,67	3,65	11,30	0,8	2,80
1111046	APKT 100312 PDFR-X			○		⊗			○	⊗	○	○		⊗				⊗			6,67	3,65	11,30	1,2	2,80
1111072	APKT 100312 PDER-X	⊗	⊗	○		⊗	⊗	⊗	⊗	⊗	○	○		⊗			⊗	⊗			6,67	3,65	11,30	1,2	2,80
1111045	APKT 100312 PDTR-X	⊗	⊗			⊗								⊗				⊗			6,67	3,65	11,30	1,2	2,80
1110987	APKT 100312 PDSR-X	⊗	⊗			⊗								⊗				⊗			6,67	3,65	11,30	1,2	2,80

⊗ Stock items / Itens de stock ○ Available under request / Disponibilidade sob consulta / Disponible bajo consulta

(1) Insert Order Code = Geometry Code + Grade Code

FRAISES MODULARES A RAINURER / MODULAR MILLING TOOLS

R15090

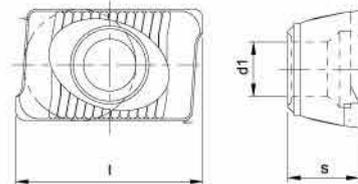
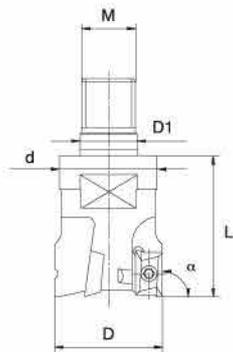

Order Code	REF.	Dimensione Dimensões Dimensiones								Spare parts Accesorios Accesorios		Insert Paletilla Paletilla	Stock
		α	D	D1	L	d	Z	M	l x s				
241014800	025R15090-02-07-M12	90°	25	12,5	35	21	2	12	15,85x5,60	P0401100	XT15	ADKT 1505...	
241014900	032R15090-03-07-M16	90°	32	17,0	43	29	3	16	15,85x5,60	P0401100	XT15	ADKT 1505...	

ADKT 1505

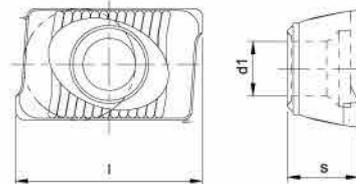
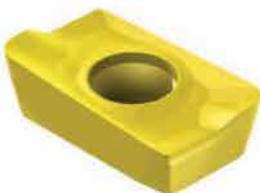

		GRADES Grupos Grados																							
		P				M				K				N		S		H							
		CC	CC	CC	CC	CC	CC	CC	CC	CC	CC	UC	CC	UC	CC	CC	CC	CC	CC	Dimensione Dimensões Dimensiones					
(1) Grade Code		86	78	54	64	68	86	78	67	68	67	54	10	68	10	D6	78	68	64	D4	d	s	l	R	d1
(1) Geometry Code	ISO	PH6135	PH6125	PH6910	PH6903	PH6920	PH6135	PH6125	PH6315	PH6920	PH6315	PH6910	PH0910	PH6920	PH0310	PDP410	PH6125	PH6920	PH6903	PBH910	d	s	l	R	d1
1110611	ADKT 1505 PDFR																				9,53	5,60	15,85	0,8	4,40
1110006	ADKT 1505 PDER																				9,53	5,60	15,85	0,8	4,40
1111209	ADKT 1505 PDTR																				9,53	5,60	15,85	0,8	4,40
1111218	ADKT 1505 PDSR																				9,53	5,60	15,85	0,8	4,40

Stock items / Itens de stock Available under request / Disponibilidade sob consulta / Disponible bajo consulta.

(1) Insert Order Code = Geometry Code + Grade Code

FRAISES MODULARES A RAINURER / MODULAR MILLING TOOLS

R49095 | R45095

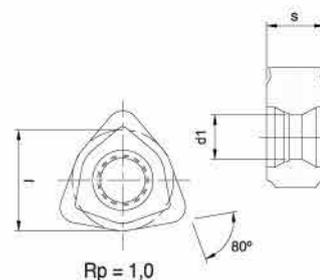
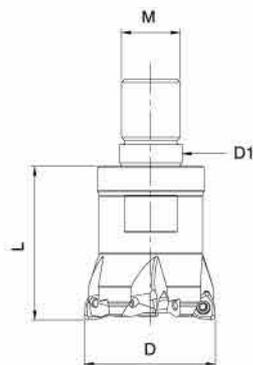

Order Code	REF.	Dimensione Dimensões Διαστάσεις								Spare parts Απαιτούμενα Acessórios		Insert Παξιλιό Παξιλάκι	Stock
		α	Rp	D	D1	M	L	Z	lxS				
241030400	016R49095-02-07-M08	95°	1,0	16	8,5	8	28	2	6,35X3,62	P0250700	XT07	WNHU 04T310	
241028600	020R49095-03-07-M10	95°	1,0	20	10,5	10	30	3	6,35X3,62	P0250700	XT07	WNHU 04T310	
241030500	025R49095-04-07-M12	95°	1,0	25	12,5	12	30	4	6,35X3,62	P0250700	XT07	WNHU 04T310	
181037500	025R45095-02-07-M12	95°	1,0	25	12,5	12	30	2	9,52X4,76	P0350902	XT09	WNKU 060410	
181037600	035R45095-03-07-M16	95°	1,0	35	17,0	16	35	3	9,52X4,76	P0350902	XT09	WNKU 060410	
181037700	042R45095-04-07-M16	95°	1,0	42	17,0	16	35	4	9,52X4,76	P0350902	XT09	WNKU 060410	

WNHU

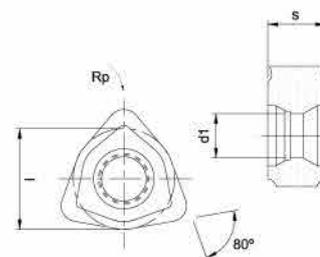

		GRADES Γραμς Grados																						
		P				M				K				N		S		H						
		CC	CC	CC	CC	CC	CC	CC	CC	CC	CC	UC	CC	UC	CC	CC	CC	CC	CC	Dimensione Διαστάσεις Διαστάσεις				
		(1) Grade Code																						
		PH6135	PH6125	PH6910	PH6903	PH6920	PH6135	PH6125	PH6315	PH6920	PH6315	PH6910	PH0910	PH6920	PH0310	PDP410	PH6125	PH6920	PH6903	PBH910	d	s	l	R
1110783	WNHU 04T310																				2,8	3,62	6,35	1,0
1111259	WNKU 060410																				4,3	4,76	9,52	1,0

Stock items / Itens de stock Available under request / Disponibilidade sob consulta / Disponible bajo consulta

(1) Insert Order Code = Geometry Code + Grade Code

FRAISES MODULARES A RAINURER / MODULAR MILLING TOOLS

**R41095 | R40095
R40595**

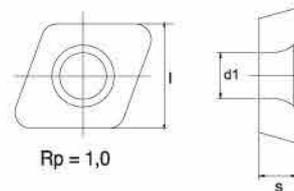
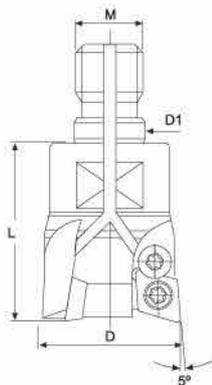

Order Code	REF.	Dimensiones Dimensões Dimensiones							Spare parts Acessórios Accesorios			Insert Pastilha Placuita	Stock
		α	D	D1	L	d	Z	lxS					
241012400	010R41095-02-07-M06	95°	10	6,5	20	10,0	2	4,0x1,59	-	P0180501	XT06	XDHW 040110	
241016300	012R41095-02-07-M06	95°	12	6,5	20	10,0	2	4,0x1,59	-	P0180501	XT06	XDHW 040110	
241012100	016R40095-02-07-M08	95°	16	8,5	23	13,6	2	6,5x2,38	-	P0250503	XT07	XDHW 060210	
241012200	020R40095-03-07-M10	95°	20	10,5	28	18,0	3	6,5x2,38	-	P0250503	XT07	XDHW 060210	
241034000	025R40095-04-07-M12	95°	25	12,5	32	21,0	4	6,5x2,38	-	P0250503	XT07	XDHW 060210	
241015700	025R40595-02-07-M12	95°	25	12,5	35	21,0	2	10,0x3,97	P0300750	P0350900	XT15	XDHW 10T310	
241012300	035R40595-03-07-M16	95°	35	17,0	43	29,0	3	10,0x3,97	P0300750	P0350900	XT15	XDHW 10T310	
241016900	042R40595-04-07-M16	95°	42	17,0	43	29,0	4	10,0x3,97	P0300750	P0350900	XT15	XDHW 10T310	

XDHW

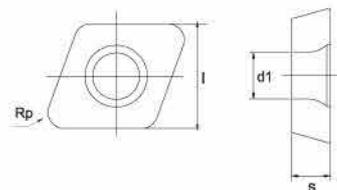

		GRADES Graus Grados																						
		P				M				K				N		S		H						
		CC	CC	CC	CC	CC	CC	CC	CC	CC	CC	UC	CC	UC	CC	CC	CC	CC	CC	Dimensiones Dimensões Dimensiones				
		(1) Grade Code																						
(1) Geometry Code	ISO	PH6135	PH6125	PH6910	PH6903	PH6920	PH6135	PH6125	PH6315	PH6920	PH6315	PH6910	PH0910	PH6920	PH0310	PDP410	PH6125	PH6920	PH6903	PBH910	S	I	R	d1
1110573	XDHW 040110																				1,59	4,00	1,0	2,00
1110532	XDHW 060210																				2,38	6,50	1,0	2,80
1110565	XDHW 10T310																				3,97	10,00	1,0	3,80

Stock items / Itens de stock Available under request / Disponibilidade sob consulta / Disponible bajo consulta

(1) Insert Order Code = Geometry Code + Grade Code

FRAISES MODULARES A RAINURER / MODULAR MILLING TOOLS

R06590

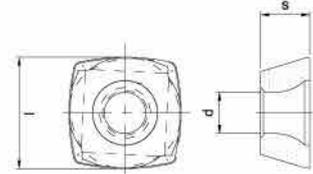
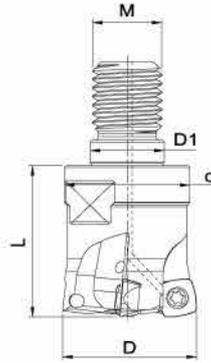

Order Code	REF.	Dimensione Dimensões Dimensiones						Spare parts Acessórios Accesorios		Insert Paletina Plaquita	Stock
		Rp	D	D1	M	L	lxS				
241031100	020R06590-02-05-M10	1,8	20	10,5	M10	25	8,5x3,97	P0300800	XT09	SPKW / SPKT 08T308	
241029400	025R06590-03-05-M12	1,8	25	12,5	M12	28	8,5x3,97	P0300800	XT09	SPKW / SPKT 08T308	
241029600	032R06590-04-05-M16	1,8	32	16,5	M16	35	8,5x3,97	P0300800	XT09	SPKW / SPKT 08T308	
241031000	042R06590-05-05-M16	1,8	42	17,0	M16	35	8,5x3,97	P0300800	XT09	SPKW / SPKT 08T308	

SPKW | SPKT

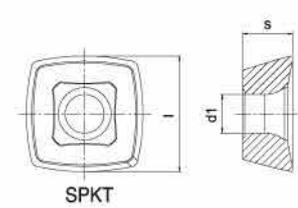
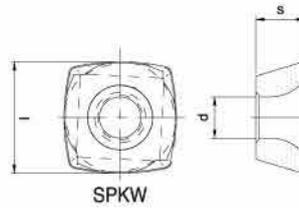

		GRADES Graus Grados																					
		P					M				K			N		S		H					
		CC	CC	CC	CC	CC	CC	CC	CC	CC	CC	CC	UC	CC	UC	CC	CC	CC	CC	CC	Dimensione Dimensões Dimensiones		
(1) Grade Code		86	78	54	64	68	86	78	67	68	67	54	10	68	10	D8	78	68	64	D4	d	s	l
(1) Geometry Code	ISO	PH6135	PH6125	PH6910	PH6903	PH6920	PH6135	PH6125	PH6315	PH6920	PH6315	PH6910	PH0910	PH6920	PH0310	PDP410	PH6125	PH6920	PH6903	PBH910			
1121227	SPKW 08T308																				3,4	3,97	8,5
1111314	SPKT 08T308																				3,4	3,97	8,5

Stock items / Itens de stock Available under request / Disponibilidade sob consulta / Disponible bajo consulta

(1) Insert Order Code = Geometry Code + Grade Code

FRAISES MODULARES A RAINURER / MODULAR MILLING TOOLS

**R24090 | R24590 | R25090
R25190 | R25290**

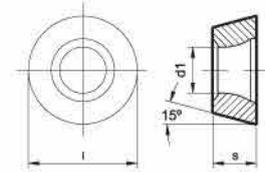
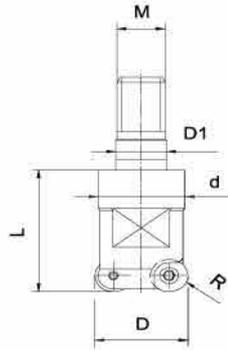

Order Code	REF.	Dimensions Dimensões Dimensiones								Spare parts Acessórios Accesorios		Insert Pastilla Placota	Stock
		R	D	D1	L	d	Z	M	lxS				
241011300	012R24090-02-M06	3,5	12	6,5	28	10,0	2	6	7x1,98	P0250501	XT07	RD... 07T1MOT	
241015400	015R24590-03-M08	3,5	15	8,5	28	17,5	3	8	7x2,38	P0250500	XT07	RD... 0702MOT	
241019100	016R24590-02-M08	3,5	16	8,5	28	17,5	2	8	7x2,38	P0250500	XT07	RD... 0702MOT	
241011400	020R24590-04-M10	3,5	20	10,5	28	18,0	4	10	7x2,38	P0250500	XT07	RD... 0702MOT	
241011500	020R25090-02-M10	5,0	20	10,5	28	18,0	2	10	10x3,18	P0350701	XT15	RD... 1003MOT	
241011600	025R25090-03-M12	5,0	25	12,5	33	21,0	3	12	10x3,18	P0350701	XT15	RD... 1003MOT	
241011700	030R25090-04-M16	5,0	30	17,0	42	29,0	4	16	10x3,18	P0350701	XT15	RD... 1003MOT	
241015500	035R25090-05-M16	5,0	35	17,0	42	29,0	5	16	10x3,18	P0350701	XT15	RD... 1003MOT	
241011800	024R25190-02-M12	6,0	24	12,5	33	21,0	2	12	12x3,97	P0350800	XT20	RD... 12T3MOT	
241011900	035R25190-03-M16	6,0	35	17,0	42	29,0	3	16	12x3,97	P0350800	XT20	RD... 12T3MOT	
241012000	042R25190-04-M16	6,0	42	17,0	42	29,0	4	16	12x3,97	P0350800	XT20	RD... 12T3MOT	
241002600	032R25290-02-M16	8,0	32	17,0	42	29,0	2	16	16x4,76	P0451001	XT20	RD... 1604MOT	
241034800	035R25290-03-M16	8,0	35	17,0	42	29,0	3	16	16x4,76	P0451001	XT20	RD... 1604MOT	

FRAISES MODULARES A RAINURER / MODULAR MILLING TOOLS

**RDMW | RDHW
RDMT | RDHT**

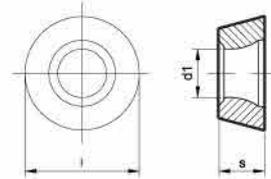

		GRADES Graus Grados																					
		P					M				K				N		S		H				
		CC	CC	CC	CC	CC	CC	CC	CC	CC	CC	CC	UC	CC	UC	CC	CC	CC	CC	CC	Dimensões Dimensões Dimensiones		
		(1) Grade Code																		l	s	d1	
(1) Geometry Code	ISO	PH6135	PH6125	PH6910	PH6903	PH6920	PH6135	PH6125	PH6315	PH6920	PH6315	PH6910	PH0910	PH6920	PH0310	PDP410	PH6125	PH6920	PH6903	PBH910	l	s	d1
1110616	RDHW 07T1 MOT	⊗	⊗	⊗	⊗	⊗	⊗	⊗	⊗	⊗	⊗	⊗	⊗	⊗			⊗	⊗	⊗	7	1,98	2,8	
1110548	RDHW 0702 MOT	⊗	⊗	⊗	⊗	⊗	⊗	⊗	⊗	⊗	⊗	⊗	⊗	⊗			⊗	⊗	⊗	7	2,38	2,8	
1110087	RDHW 1003 MOT	⊗	⊗	⊗	⊗	⊗	⊗	⊗	⊗	⊗	⊗	⊗	⊗	⊗			⊗	⊗	⊗	10	3,18	4,0	
1110090	RDHW 12T3 MOT	⊗	⊗	⊗	⊗	⊗	⊗	⊗	⊗	⊗	⊗	⊗	⊗	⊗			⊗	⊗	⊗	12	3,97	4,0	
1110092	RDHW 1604 MOT	⊗	⊗	⊗	⊗	⊗	⊗	⊗	⊗	⊗	⊗	⊗	⊗	⊗			⊗	⊗	⊗	16	4,76	5,2	
1110549	RDMW 1003 MOT	⊗	⊗				⊗	⊗	⊗	⊗	⊗	⊗	⊗	⊗			⊗	⊗	⊗	10	3,18	4,0	
1110096	RDMW 12T3 MOT	⊗	⊗				⊗	⊗	⊗	⊗	⊗	⊗	⊗	⊗			⊗	⊗	⊗	12	3,97	4,0	
1110097	RDMW 1604 MOT	⊗	⊗				⊗	⊗	⊗	⊗	⊗	⊗	⊗	⊗			⊗	⊗	⊗	16	4,76	5,2	
1110082	RDHT 1003 MOT	⊗	⊗	⊗	⊗		⊗	⊗	⊗	⊗	⊗	⊗	⊗	⊗			⊗	⊗	⊗	10	3,18	4,0	
1110083	RDHT 12T3 MOT	⊗	⊗	⊗	⊗		⊗	⊗	⊗	⊗	⊗	⊗	⊗	⊗			⊗	⊗	⊗	12	3,97	4,0	
1110084	RDHT 1604 MOT	⊗	⊗	⊗	⊗		⊗	⊗	⊗	⊗	⊗	⊗	⊗	⊗			⊗	⊗	⊗	16	4,76	5,2	
1110583	RDMT 1003 MOT	⊗	⊗				⊗	⊗	⊗	⊗	⊗	⊗	⊗	⊗			⊗	⊗	⊗	10	3,18	4,0	
1110558	RDMT 12T3 MOT	⊗	⊗				⊗	⊗	⊗	⊗	⊗	⊗	⊗	⊗			⊗	⊗	⊗	12	3,97	4,0	
1110556	RDMT 1604 MOT	⊗	⊗				⊗	⊗	⊗	⊗	⊗	⊗	⊗	⊗			⊗	⊗	⊗	16	4,76	5,2	

⊗ Stock items / Itens de stock ⊗ Available under request / Disponibilidade sob consulta / Disponible bajo consulta

(1) Insert Order Code = Geometry Code + Grade Code

FRAISES MODULARES A RAINURER / MODULAR MILLING TOOLS

R08190 | R08390

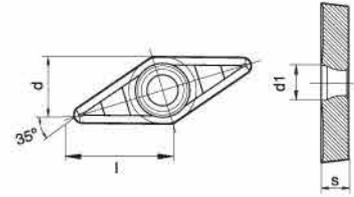
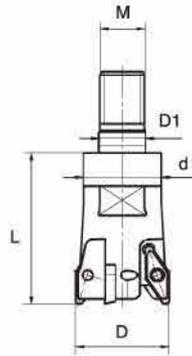

Order Code	REF.	Dimensions Dimensões Dimensiones							Spare parts Acessórios Accesorios		Insert Pastilla Plaquita	Stock
		M	D	D1	d	L	Z	lxS				
241020900	015R08190-02-M08	8	15	8,5	13,5	36	2	11,03x3,18	P0250500	XT07	VCGT 1103xxFN-AL	
241021000	020R08190-02-M10	10	20	10,5	18,0	36	2	11,03x3,18	P0250500	XT07	VCGT 1103xxFN-AL	
241021100	025R08190-03-M12	12	25	12,5	21,0	41	3	11,03x3,18	P0250500	XT07	VCGT 1103xxFN-AL	
241019900	032R08390-02-M16	16	32	17,0	29,0	48	2	21,95x5,55	P0451200	XT20	VCGT 2205xxFN-AL	

VCGT

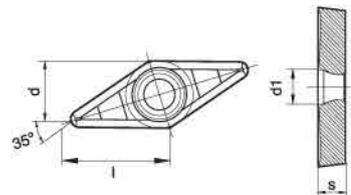

		GRADES Grupos Grados																						
		P				M				K				N		S		H						
		CC	CC	CC	CC	CC	CC	CC	CC	CC	CC	UC	CC	UC	CC	CC	CC	CC	CC	Dimensiones Dimensões Dimensiones				
		(1) Grade Code																d	s	d1	l			
(1) Geometry Code	ISO	PH6135	PH6125	PH6910	PH6903	PH6920	PH6135	PH6125	PH6315	PH6920	PH6315	PH6910	PH0910	PH6920	PH0310	PDP410	PH6125	PH6920	PH6903	PBH910	d	s	d1	l
2110085	VCGT 110302 FN-AL																				6,25	3,18	2,8	11,03
2110086	VCGT 110304 FN-AL																				6,25	3,18	2,8	11,03
2110087	VCGT 110308 FN-AL																				6,25	3,18	2,8	11,03
2110094	VCGT 220525 FN-AL																				12,5	5,55	7,5	21,95
2110095	VCGT 220530 FN-AL																				12,5	5,55	7,5	21,95

Stock items / Itens de stock Available under request / Disponibilidade sob consulta / Disponible bajo consulta

(1) Insert Order Code = Geometry Code + Grade Code

FRAISES A COPIER / END MILL TOOLS

E61090

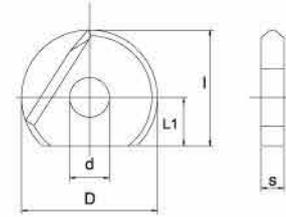
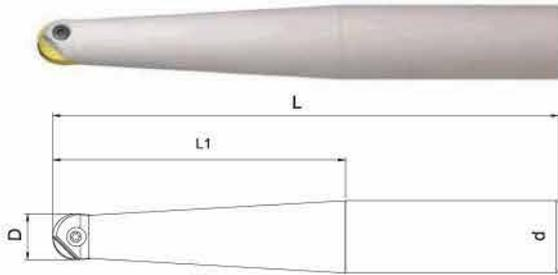

Order Code	REF.	Dimensions Dimensões Dimensiones				Spare parts Acessórios Accesorios		Insert Pastilla Plaquita	Stock
		D	d	L1	L				
241032000	008E61090-01-12110	8	12	53	110	P0250725	XT07	WPZ 08	
241032100	008E61090-01-12132	8	12	75	132	P0250725	XT07	WPZ 08	
241032200	010E61090-01-12110	10	12	53	110	P0300925	XT08	WPZ 10	
241032300	010E61090-01-12132	10	12	75	132	P0300925	XT08	WPZ 10	
241032400	012E61090-01-16145	12	16	85	145	P0351025	XT10	WPZ 12	
241031800	016E61090-01-20166	16	20	100	166	P0401325	XT15	WPZ 16	
241031900	020E61090-01-25191	20	25	150	191	P0501625	XT20	WPZ 20	
241032500	025E61090-01-32215	25	32	135	215	P0602025	XT30	WPZ 25	

*Other dimensions available under request | Outras dimensões sob consulta | Dimensiones bajo cotización

R61090

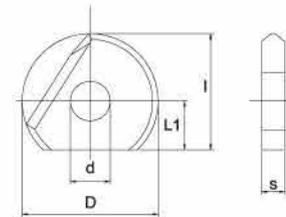
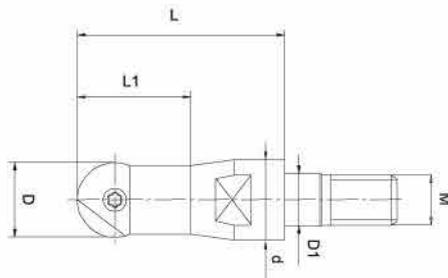

Order Code	REF.	Dimensions Dimensões Dimensiones						Spare parts Acessórios Accesorios		Insert Pastilla Plaquita	Stock
		D	D1	L1	L	d	M				
241012500	008R61090-01-M06	8	6,5	13	23	9,8	6	P0250725	XT07	WPZ 08	
241017600	010R61090-01-M06	10	6,5	23	23	9,8	6	P0300925	XT08	WPZ 10	
241015800	012R61090-01-M06	12	6,5	23	23	9,8	6	P0351025	XT10	WPZ 12	
241015900	016R61090-01-M08	16	8,5	28	28	13,6	8	P0401325	XT15	WPZ 16	
241016000	020R61090-01-M10	20	10,5	28	28	18,0	10	P0501526	XT20	WPZ 20	
241033600	025R61090-01-M12	25	12,5	42	42	20,8	12	P0602025	XT25	WPZ 25	

Stock items / Itens de stock. Available under request / Disponibilidade sob consulta / Disponible bajo consulta

FRAISES A COPIER / END MILL TOOLS

WPZ

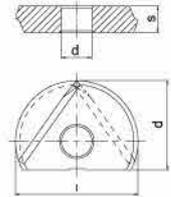

WPZ

		GRADES Grados Gradios																					
		P				M				K				N		S		H					
		CC	CC	CC	CC	CC	CC	CC	CC	CC	CC	UC	CC	UC	CC	CC	CC	CC	CC	Dimensions Dimensões Dimensiones			
		(1) Grade Code																D	S	d1			
(1) Geometry Code	ISO	PH6135	PH6125	PH6910	PH6903	PH6920	PH6135	PH6125	PH6315	PH6920	PH6315	PH6910	PH0910	PH6920	PH0310	PDP410	PH6125	PH6920	PH6903	PBI910	D	S	d1
1110543	WPZ 8			⊙	⊙	⊙					⊙	⊙	⊙				⊙	⊙	⊙		8,0	2,4	2,5
1110551	WPZ 10			⊙	⊙	⊙					⊙	⊙	⊙				⊙	⊙	⊙		10,0	2,6	3,0
1110552	WPZ 12			⊙	⊙	⊙					⊙	⊙	⊙				⊙	⊙	⊙		12,0	3,0	3,5
1110544	WPZ 16			⊙	⊙	⊙					⊙	⊙	⊙				⊙	⊙	⊙		16,0	4,0	4,0
1110553	WPZ 20			⊙	⊙	⊙					⊙	⊙	⊙				⊙	⊙	⊙		20,0	5,0	5,0
1110661	WPZ 25			⊙	⊙	⊙					⊙	⊙	⊙				⊙	⊙	⊙		25,0	6,0	6,0
1110662	WPZ 32			⊙	⊙	⊙					⊙	⊙	⊙				⊙	⊙	⊙		32,0	7,0	8,0

⊙ Stock / itens / Itens de stock ○ Available under request / Disponibilidade sob consulta / Disponible bajo consulta

(1) Insert Order Code = Geometry Code + Grade Code

FRAISES A COPIER / END MILL TOOLS

E60090

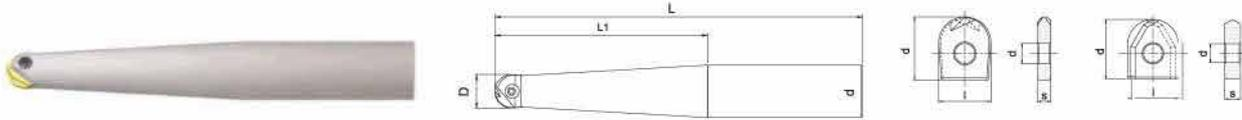

Order Code	REF.	Dimensions Dimensões Dimensiones				Spare parts Acessórios Accesorios		Insert Pastilhas Plaquitas	Stock
		D	d	L	L1				
241005700	010E60090-01-12105	10	12	105	50	P0400925	XT15	WPR P 10 WPR X 10	
241016400	012E60090-01-16105	12	16	105	50	P0501025	XT20	WPR P 12 WPR X 12	
241006100	016E60090-01-20105	16	20	105	50	P0501325	XT20	WPR P 16 WPR X 16	
241006300	020E60090-01-25125	20	25	125	70	P0501525	XT20	WPR P 20 WPR X 20	
241035500	025E60090-01-32125	25	32	125	70	P0602025	XT30	WPR P 25 WPR X 25	
241035600	032E60090-01-32125	32	32	125	70	P0802525	XT30	WPR P 32 WPR X 32	
241005800	010E60090-01-12150	10	12	150	80	P0400925	XT15	WPR P 10 WPR X 10	
241006000	012E60090-01-16160	12	16	160	90	P0501025	XT20	WPR P 12 WPR X 12	
241006200	016E60090-01-20180	16	20	180	100	P0501325	XT20	WPR P 16 WPR X 16	
241006400	020E60090-01-25200	20	25	200	120	P0501525	XT20	WPR P 20 WPR X 20	
241035800	025E60090-01-32220	25	32	220	140	P0602025	XT30	WPR P 25 WPR X 25	
241035700	032E60090-01-32250	32	32	250	160	P0802525	XT30	WPR P 32 WPR X 32	

WPR P | WPR X

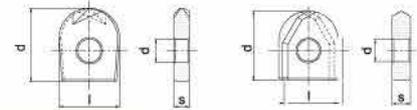
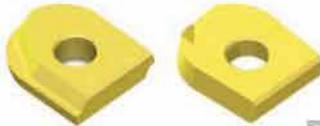

		GRADES Graus Grados																					
		P				M				K		N		S		H							
		CC	CC	CC	CC	CC	CC	CC	CC	CC	CC	UC	CC	UC	CC	CC	CC	CC	CC	Dimensions Dimensões Dimensiones			
		(1) Grade Code																					
(1) Geometry Code	ISO	PH6135	PH6125	PH6910	PH6903	PH6920	PH6135	PH6125	PH6315	PH6920	PH6315	PH6910	PH0910	PH6920	PH0310	PDP410	PH6125	PH6920	PH6903	PBH910	D	S	d1
1110930	WPR-P 8																				8,0	2,5	2,5
1110825	WPR-P 10																				10,0	2,5	4,0
1110826	WPR-P 12																				12,0	2,5	5,0
1110184	WPR-P 16																				16,0	3,0	5,0
1110185	WPR-P 20																				20,0	3,0	5,0
1110186	WPR-P 25																				25,0	4,0	6,0
1111038	WPR-P 32																				32,0	5,0	8,0
1111030	WPR-X 8																				8,0	2,0	2,5
1111031	WPR-X 10																				10,0	2,5	4,0
1111032	WPR-X 12																				12,0	2,5	5,0
1111033	WPR-X 16																				16,0	3,0	5,0
1110571	WPR-X 20																				20,0	3,0	5,0
1111035	WPR-X 25																				25,0	4,0	6,0
1111036	WPR-X 32																				32,0	5,0	8,0

Stock items / Itens de stock Available under request / Disponibilidade sob consulta / Disponible bajo consulta

(1) Insert Order Code = Geometry Code + Grade Code

FRAISES A COPIER / END MILL TOOLS

R60590

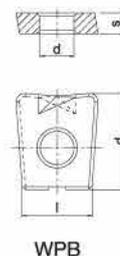
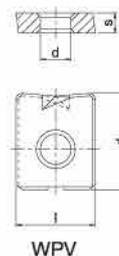
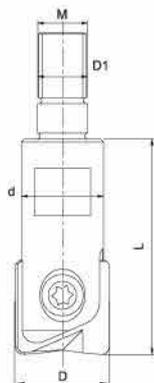

Order Code	REF.	Dimensions Dimensões Dimensiones					Spare parts Acessórios Accesorios		Insert Paquíta Flanqueta	Stock
		D	D1	L	d	M				
241028300	008R60590-01-M06	8	6,5	24,0	9,8	6,0	P0300725	XT08	WPV 08 WPB 08	
241027100	010R60590-01-M06	10	6,5	23,0	9,8	6,0	P0400925	XT15	WPV 10 WPB 10	
241027200	012R60590-01-M06	12	6,5	28,5	9,8	6,0	P0501025	XT20	WPV 12 WPB 12	
241027300	016R60590-01-M08	16	8,5	36,5	13,0	8,0	P0501325	XT20	WPV 16 WPB 16	
241027400	020R60590-01-M10	20	10,5	40,0	18,0	10,0	P0501525	XT20	WPV 20 WPB 20	

WPV | WPB

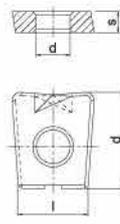
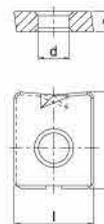
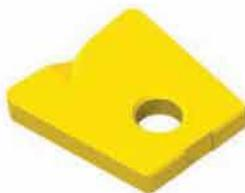

(1) Geometry Code	ISO	GRADES Graus Grados																WPV		WPB						
		P					M				K			N		S		H		Dimensions Dimensões Dimensiones						
		CC	CC	CC	CC	CC	CC	CC	CC	CC	CC	CC	UC	CC	CC	CC	CC	CC	CC	CC	D	S	d1	R		
	(1) Grade Code	86	78	54	64	68	86	78	67	68	67	54	10	68	10	D6	78	68	64	D4						
		PH6135	PH6125	PH6910	PH6903	PH6920	PH6135	PH6125	PH6315	PH6920	PH6315	PH6910	PH0910	PH6920	PH0310	PDP410	PH6125	PH6920	PH6903	PBH910						
1110820	WPV 8																						8,0	2,0	3,0	0,6
1110821	WPV 10																						10,0	2,5	4,0	1,0
1110822	WPV 12																						12,0	2,5	5,0	1,0
1110948	WPV 16																						16,0	3,0	5,0	1,3
1111020	WPV 20																						20,0	3,0	5,0	1,6
1110851	WPB 8																						8,0	2,0	3,0	0,6
1110852	WPB 10																						10,0	2,5	4,0	1,0
1110853	WPB 12																						12,0	2,5	5,0	1,0
1110923	WPB 16																						16,0	3,0	5,0	1,3
1111019	WPB 20																						20,0	3,0	5,0	1,6

 Stock / itens / Itens de stock  Available under request / Disponibilidade sob consulta / Disponible bajo consulta

(1) Insert Order Code = Geometry Code + Grade Code

FRAISES MODULARES EN CARBURE SOLID CARBIDE - MODULAR MILLING HEADS

BM 2000

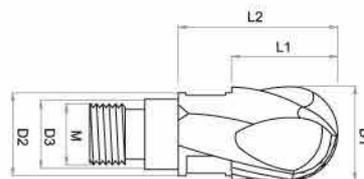

Order Code	REF.	Dimensions Dimensões Dimensiones					Stock
		D1	L1	D2	L2	M	
211140300	BM2012-1208	12	12	11,5	20	M08	⊗
211140600	BM2016-1610	16	16	15,5	26	M10	⊗
211140700	BM2020-2012	20	20	19,0	31	M12	⊗
211140800	BM2025-2514	25	25	24,0	37	M14	○
211140900	BM2032-3218	32	32	30,0	46	M18	○

BM 4000

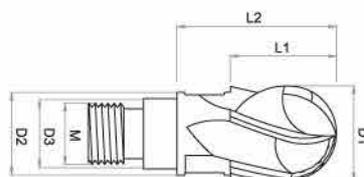

Order Code	REF.	Dimensions Dimensões Dimensiones					Stock
		D1	L1	D2	L2	M	
211143800	BM4012-1208	12	12	11,5	20	M08	⊗
211143900	BM4016-1610	16	16	15,5	26	M10	⊗
211144400	BM4020-2012	20	20	19,0	31	M12	⊗
211144500	BM4025-2514	25	25	24,0	37	M14	○
211144600	BM4032-3218	32	32	30,0	46	M18	○

⊗ Stock itens / Itens de stock ○ Available under request / Disponibilidade sob consulta / Disponible bajo consulta.

FRAISES MODULARES EN CARBURE SOLID CARBIDE - MODULAR MILLING HEADS

EM 4000

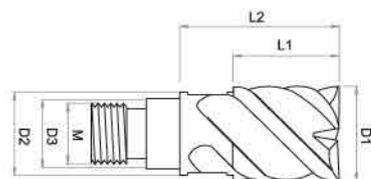

Order Code	REF.	Dimensões Dimensões Dimensões					Stock
		D1	L1	D2	L2	M	
211144700	EM4012-1208	12	12	11,5	20	M08	⊗
211144800	EM4016-1610	16	16	15,5	26	M10	⊗
211144900	EM4020-2012	20	20	19,0	31	M12	⊗
211145000	EM4025-2514	25	25	24,0	37	M14	○
211145100	EM4032-3218	32	32	30,0	46	M18	○

EMX

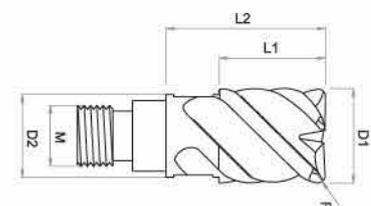

Order Code	REF.	Dimensões Dimensões Dimensões						Stock
		R	D1	L1	D2	L2	M	
211145200	EMX0512-1208	0,5	12	12	11,5	20	M08	⊗
211145300	EMX1012-1208	1,0	12	12	11,5	20	M08	○
211145400	EMX2012-1208	2,0	12	12	11,5	20	M08	○
211145500	EMX1016-1610	1,0	16	16	15,5	26	M10	⊗
211145600	EMX2016-1610	2,0	16	16	15,5	26	M10	○
211145700	EMX3016-1610	3,0	16	16	15,5	26	M10	○
211145800	EMX1020-2012	1,0	20	20	19,0	31	M12	⊗
211145900	EMX2020-2012	2,0	20	20	19,0	31	M12	○
211146000	EMX3020-2012	3,0	20	20	19,0	31	M12	○
211146100	EMX1025-2514	1,0	25	25	24,0	37	M14	○
211146200	EMX3025-2514	3,0	25	25	24,0	37	M14	○
211146300	EMX5025-2514	5,0	25	25	24,0	37	M14	○
211146400	EMX3032-3218	3,0	32	32	30,5	46	M18	○
211146500	EMX5032-3218	5,0	32	32	30,5	46	M18	○

⊗ Stock items / Itens de stock ○ Available under request / Disponibilidade sob consulta / Disponible bajo consulta

FRAISES MODULAIRES EN CARBURE SOLID CARBIDE - MODULAR MILLING HEADS

UW 6000

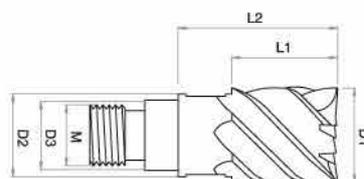

Order Code	REF.	Dimensions Dimensões Dimensiones					Stock
		D1	L1	D2	L2	M	
211146600	UW6012-1208	12	12	11,5	20	M08	⊗
211146700	UW6016-1610	16	16	15,5	26	M10	⊗
211146800	UW6020-2012	20	20	19,0	31	M12	⊗
211146900	UW6025-2514	25	25	24,0	37	M14	○

UWX

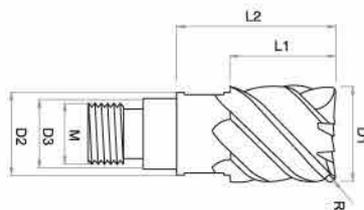

Order Code	REF.	Dimensions Dimensões Dimensiones						Stock
		R	D1	L1	D2	L2	M	
211147000	UWX0512-1208	0,5	12	12	11,5	20	M08	⊗
211147100	UWX1012-1208	1,0	12	12	11,5	20	M08	○
211147200	UWX0516-1610	0,5	16	16	15,5	26	M10	⊗
211147300	UWX1016-1610	1,0	16	16	15,5	26	M10	○
211147400	UWX2016-1610	2,0	16	16	15,5	26	M10	○
211147500	UWX1020-2012	1,0	20	20	19,0	31	M12	⊗
211147600	UWX1025-2514	1,0	25	25	24,0	37	M14	○
211147700	UWX2025-2514	2,0	25	25	24,0	37	M14	○
211147800	UWX3025-2514	3,0	25	25	24,0	37	M14	○

⊗ Stock items / Itens de stock ○ Available under request / Disponibilidade sob consulta / Disponible bajo consulta

RALLONGES / SHANK EXTENSIONS

**Anti-Vibration
Material**

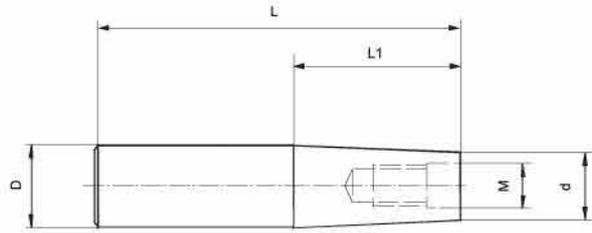

Order Code	REF.	Dimensiones Dimensões Dimensiones					Stock
		D	L1	L	d	M	
1191009A0	AC-RI-D12-M06-L060-AV	12	60	110	9,8	6	☺
1191021A0	AC-RI-D12-M06-L080-AV	12	80	130	9,8	6	☺
1191010A0	AC-RI-D16-M08-L040-AV	16	40	95	12,8	8	☺
1191011A0	AC-RI-D16-M08-L060-AV	16	60	115	12,8	8	☺
1191012A0	AC-RI-D16-M08-L080-AV	16	80	135	12,8	8	☺
1191013A0	AC-RI-D16-M08-L100-AV	16	100	155	12,8	8	☺
1191022A0	AC-RI-D16-M08-L120-AV	16	120	175	12,8	8	☺
1191014A0	AC-RI-D20-M10-L040-AV	20	40	100	15,8	10	☺
1191015A0	AC-RI-D20-M10-L060-AV	20	60	120	15,8	10	☺
1191016A0	AC-RI-D20-M10-L080-AV	20	80	140	15,8	10	☺
1191017A0	AC-RI-D20-M10-L100-AV	20	100	160	15,8	10	☺
1191018A0	AC-RI-D20-M10-L120-AV	20	120	180	15,8	10	☺
1191026A0	AC-RI-D20-M10-L080-D17,8-AV	20	80	140	17,8	10	☺
1191027A0	AC-RI-D20-M10-L100-D17,8-AV	20	100	160	17,8	10	☺
1191028A0	AC-RI-D20-M10-L120-D17,8-AV	20	120	180	17,8	10	☺
1191023A0	AC-RI-D25-M12-L060-AV	25	60	125	20,8	12	☺
1191024A0	AC-RI-D25-M12-L080-AV	25	80	145	20,8	12	☺
1191025A0	AC-RI-D25-M12-L100-AV	25	100	165	20,8	12	☺

*Other dimensions available under request | Outras dimensões sob consulta | Dimensiones bajo cotización

☺ Stock items / Itens de stock ○ Available under request / Disponibilidade sob consulta / Disponible bajo consulta

RALLONGES / SHANK EXTENSIONS

Solid Carbide Shank

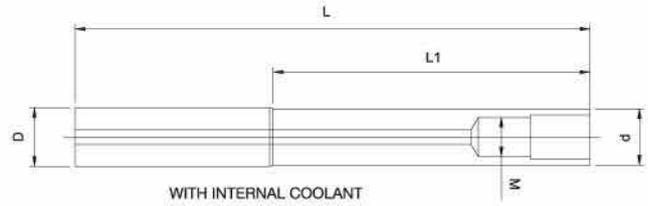

Order Code	REF.	Dimensions Dimensões Dimensiones					Stock
		D	L1	L	d	M	
229013200	ACI-RI-D12-M08-L060-HW	12	60	100	11,5	M08	Ⓢ
229013300	ACI-RI-D12-M08-L090-HW	12	90	150	11,5	M08	Ⓢ
229013400	ACI-RI-D12-M08-L120-HW	12	120	200	11,5	M08	Ⓢ
229013500	ACI-RI-D16-M10-L060-HW	16	60	100	15,5	M10	Ⓢ
229013600	ACI-RI-D16-M10-L090-HW	16	90	150	15,5	M10	Ⓢ
229013700	ACI-RI-D16-M10-L120-HW	16	120	200	15,5	M10	Ⓢ
229013800	ACI-RI-D20-M12-L060-HW	20	60	100	19,0	M12	Ⓢ
229013900	ACI-RI-D20-M12-L090-HW	20	90	150	19,0	M12	Ⓢ
229014000	ACI-RI-D20-M12-L120-HW	20	120	200	19,0	M12	Ⓢ
229014100	ACI-RI-D20-M12-L180-HW	20	180	300	19,0	M12	Ⓢ
229014200	ACI-RI-D25-M14-L120-HW	25	120	200	24,0	M14	Ⓢ
229014300	ACI-RI-D25-M14-L180-HW	25	180	300	24,0	M14	Ⓢ
229014700	ACI-RI-D32-M18-L180-HW	32	180	300	30,5	M18	Ⓢ

*Other dimensions available under request | Outras dimensões sob consulta | Dimensiones bajo cotización.

Ⓢ Stock items / Itens de stock ○ Available under request / Disponibilidade sob consulta / Disponible bajo consulta

RALLONGES / SHANK EXTENSIONS

Cylindrical in Steel



Order Code	REF.	Dimensions Dimensões Dimensiones					Stock
		D	L1	L	d	M	
229000500	AC-RI-D12-M06-L020	12	20	65	9,8	6	⊗
229000600	AC-RI-D16-M08-L040	16	40	88	12,8	8	⊗
229000700	AC-RI-D20-M10-L045	20	45	95	17,8	10	⊗
229000800	AC-RI-D25-M12-L050	25	50	106	20,8	12	⊗
229000900	AC-RI-D32-M16-L050	32	50	110	28,8	16	⊗

*Other dimensions available under request | Outras dimensões sob consulta | Dimensiones bajo cotización

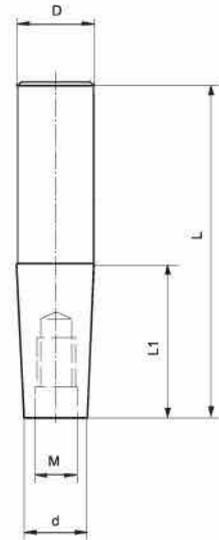

Extensions for Threaded Type Cutter



Order Code	REF.	Dimensions Dimensões Dimensiones				Stock
		D	M1	M2	L	
229003200	AL-M08-L040-M08	13,8	8	8	40	⊗
229003600	AL-M10-L060-M10	18,0	10	10	60	⊗
229003700	AL-M12-L060-M12	21,0	12	12	60	⊗
229003100	AL-M16-L060-M16	29,0	16	16	60	⊗

*Other dimensions available under request | Outras dimensões sob consulta | Dimensiones bajo cotización

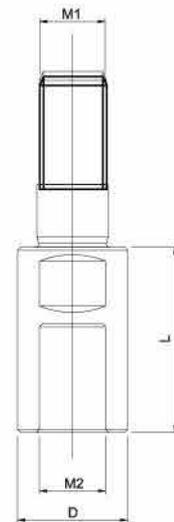

Reducers for Threaded Type Cutter



Order Code	REF.	Dimensions Dimensões Dimensiones						Stock
		M1	M2	D	d	L	L1	
229012100	AL-M08-L040-M06	8	6	13,8	10,0	40	25	⊗
229012200	AL-M10-L040-M08	10	8	18,0	13,8	40	25	⊗
229012300	AL-M12-L040-M10	12	10	21,0	18,0	40	15	⊗
229012400	AL-M16-L040-M12	16	12	29,0	21,0	40	19	⊗

*Other dimensions available under request | Outras dimensões sob consulta | Dimensiones bajo cotización

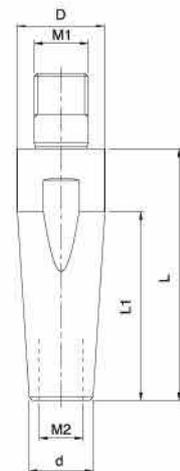

⊗ Stock itens / Itens de stock ○ Available under request / Disponibilidade sob consulta / Disponible bajo consulta

FRAISES DIAMANTEES - PLAQUETTES PCD ET CBN ULTRA HARD SOLUTIONS - PCD END MILLS

PCD TR TORIC PCD END MILL

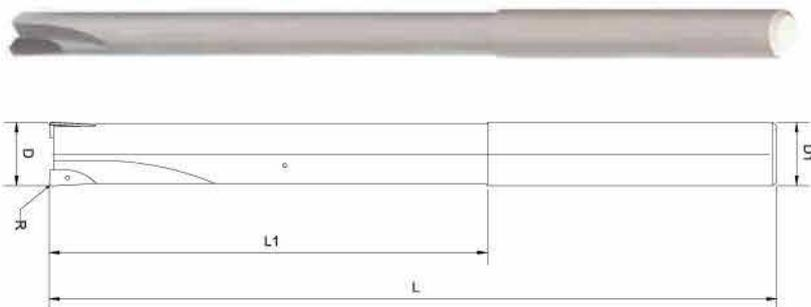

Order Code	REF.	Dimensions Dimensões Dimensiones							Stock
		Grade	D	D1	L	L1	Rp		
211058500	PCD-TR-D030-L060-R0,3	PDP 410	3	4	60	32	0,3	⊗	
211052300	PCD-TR-D040-L075-R0,3	PDP 410	4	4	75	47	0,3	⊗	
211052400	PCD-TR-D060-L100-R0,3	PDP 410	6	6	100	64	0,3	⊗	
211052500	PCD-TR-D080-L125-R0,3	PDP 410	8	8	126	90	0,3	⊗	
211052600	PCD-TR-D100-L150-R0,5	PDP 410	10	10	150	110	0,5	⊗	
211052700	PCD-TR-D120-L150-R0,5	PDP 410	12	12	150	105	0,5	⊗	

PCD BR BALL NOSE PCD END MILL

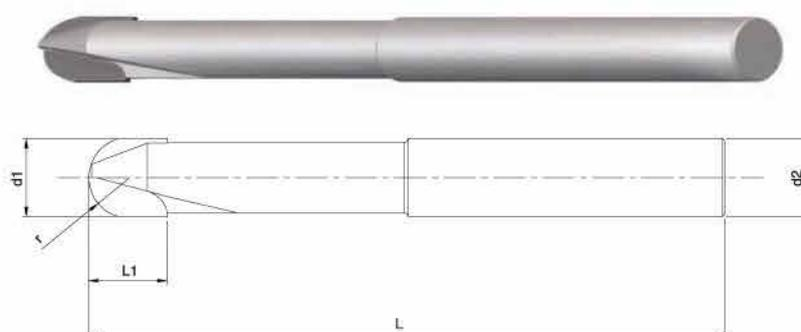

Order Code	REF.	Dimensions Dimensões Dimensiones							Stock
		Grade	∅ d1	∅ d2	L	L1	Z	Rp	
211121300	PCD-BL-D03-L060-R015	PDP 410	3	3	60	5	1	1,5	⊗
211121400	PCD-BL-D04-L060-R020	PDP 410	4	4	60	10	1	2,0	⊗
211121500	PCD-BL-D06-L080-R030	PDP 410	6	6	80	10	2	3,0	⊗
211121600	PCD-BL-D08-L080-R040	PDP 410	8	8	80	10	2	4,0	⊗
211121700	PCD-BL-D10-L080-R050	PDP 410	10	10	80	10	2	5,0	⊗
211121800	PCD-BL-D12-L100-R060	PDP 410	12	12	100	10	2	6,0	⊗

⊗ Stock items / Itens de stock ○ Available under request / Disponibilidade sob consulta / Disponible bajo consulta

FRAISES DIAMANTEES - PLAQUETTES PCD ET CBN ULTRA HARD SOLUTIONS - PCD END MILLS

RDHW PCD & CBN FULL FACE

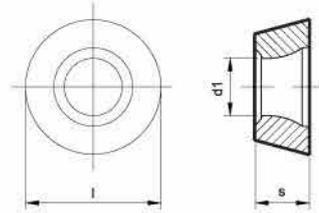

		GRADES Grades Grados																					
		P				M				K				N		S		H					
		CC	CC	CC	CC	CC	CC	CC	CC	CC	CC	UC	CC	UC	CC	CC	CC	CC	CC	CC	Dimensions Dimensões Dimensiones		
		(1) Grade Code																		I	S	D1	
(1) Geometry Code	ISO	PH6135	PH6125	PH6910	PH6903	PH6920	PH6135	PH6125	PH6315	PH6920	PH6315	PH6910	PH0910	PH6920	PH0310	PDP410	PH6125	PH6920	PH6903	PBH910	I	S	D1
2110536	RDHW 0702M0 FN																				7	2,38	2,8
2110537	RDHW 1003M0 FN																				10	3,18	3,9
2110530	RDHW 0702M0 T02020																				7	2,38	2,8
2110531	RDHW 1003M0 T02020																				10	3,18	3,9

XDHW PCD & CBN FULL FACE

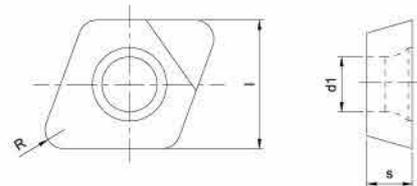
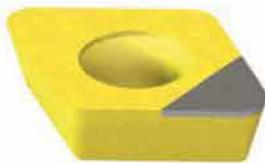

		GRADES Grades Grados																						
		P				M				K				N		S		H						
		CC	CC	CC	CC	CC	CC	CC	CC	CC	UC	CC	UC	CC	CC	CC	CC	CC	CC	CC	Dimensions Dimensões Dimensiones			
		(1) Grade Code																		S	I	R	d1	
(1) Geometry Code	ISO	PH6135	PH6125	PH6910	PH6903	PH6920	PH6135	PH6125	PH6315	PH6920	PH6315	PH6910	PH0910	PH6920	PH0310	PDP410	PH6125	PH6920	PH6903	PBH910	S	I	R	d1
2110532	XDHW 040110EN																				1,59	4,00	1,00	2,00
2110538	XDHW 040110FN																				1,59	4,00	1,00	2,00
2110533	XDHW 060210EN																				2,38	6,50	1,00	2,80
2110539	XDHW 060210FN																				2,38	6,50	1,00	2,80
2110534	XDHW 10T310EN																				3,97	10,00	1,00	3,80
2110540	XDHW 10T310FN																				3,97	10,00	1,00	3,80

⊗ Stock / itens / Itens de stock ○ Available under request / Disponibilidade sob consulta / Disponible bajo consulta

(1) Insert Order Code = Geometry Code + Grade Code

PIECES DE RECHANGES – ACCESSOIRES SPARE PARTS - ACESSORIES

	Order Code	Ref.
	212074100	CS1103

	Order Code	Ref.
	290030400	T0503509

	Order Code	Ref.
	290012100	H0140700

	Order Code	Ref.
	290011300	P0180501
	290010700	P0250500
	290004900	P0250501
	290033100	P0250503
	290013400	P0250700
	290013500	P0250725
	290026700	P0300725
	290014200	P0300750
	290009100	P0300800
	290013600	P0300925
	290032900	P0350701
	290019900	P0350800
	290017800	P0350900
	290027100	P0350902
	290013700	P0351025
	290005800	P0351200
	290013900	P0400925
	290007000	P0401100
	290021400	P0401300
	290013800	P0401325
290005200	P0451200	
290026900	P0451001	
290006700	P0451400	
290010600	P0501025	
290014400	P0501325	
290014000	P0501525	
290038800	P0501526	
290012700	P0501625	
290030200	P0602025	
290030300	P0802525	

	Order Code	Ref.
	211134500	NJ B55043

	Order Code	Ref.
	211134400	PK B55043

	Order Code	Ref.
	290012800	XT06
	290012900	XT07
	290013000	XT08
	290012400	XT15
	290013200	XT20
	290030000	XT30

	Order Code	Ref.
	290021200	XU04
	290021300	XU05

NUANCE FRAISAGE / MILLING GRADES

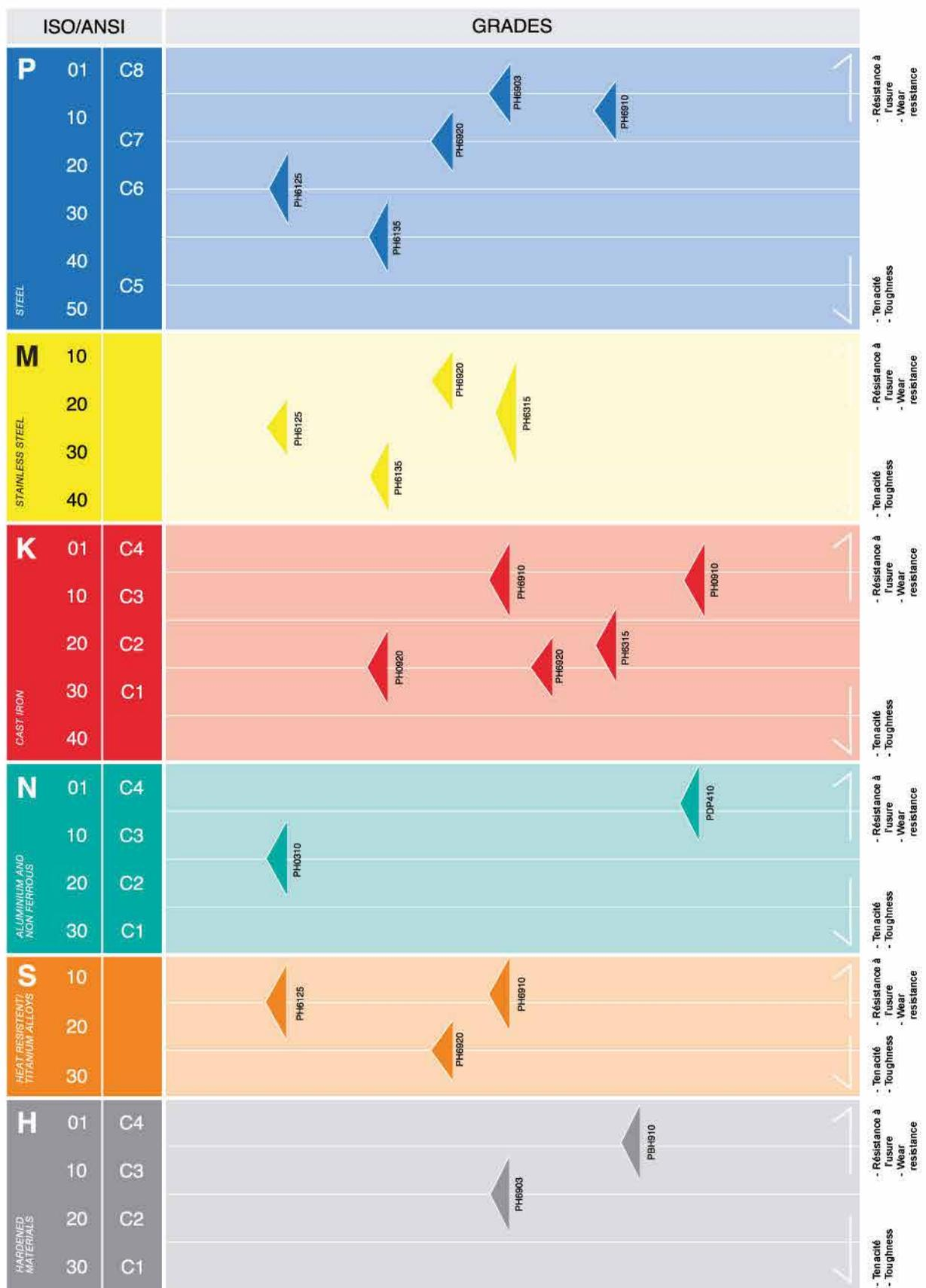

PARAMETRES DE COUPE RECOMMANDES RECOMMENDED CUTTING SPEEDS (m/min)

EBAUCHE / ROUGHING

ISO	MATERIAL	HB	Cutting speed (m/min) Velocidade de Corte (m/min) Velocidad de Corte (m/min)						
			PH6135	PH6125	PH6315	PH6910	PH6920	PH0920	PH0910
P	Unalloyed steel	125-220	150-180	170-230		200-250			
	Low-alloyed steel	220-280	140-170	150-200		190-240			
	High-alloy steel		130-160	140-180		180-230	130-150		
M	Stainless steel - Ferritic/martensitic	200-330	130-180	150-220	160-230		100-120		
	Stainless steel - Austenitic	200-330	90-155	100-145	120-150		90-110		
	Stainless steel - Austenitic-ferretic (Duplex)								
K	Malleable cast iron	130-230			170-250	180-300	150-300	130-200	170-250
	Grey cast iron	180-245			160-230	150-250	130-250	100-180	160-230
	Nodular cast iron	160-250			60-170	90-180	80-160	60-120	130-170
N	Aluminium alloys	60-130						240-320	350-600
	Copper and copper alloys	90-110						280-320	285-400
S	Heat resistant super alloys (Iron base)	200-280		50-70		35-50	35-50		35-50
	Heat resistant super alloys (Nickel base)	250-320		30-60		35-60	35-60		30-60
	Heat resistant super alloys (Cobalt base)	200-320		15-25		15-25	15-25		15-25
	Titanium alloys (400^{or}<1050[MPa])	-		40-70		40-80	40-80		40-70
H	Extra hard steel	59 HRC		30-45		30-50	30-50		

FINITION / FINISHING

ISO	MATERIAL	HB	Cutting speed (m/min) Velocidade de Corte (m/min) Velocidad de Corte (m/min)						
			PH6910	PH6920	PH6315	PH6903	PH0910	PDP410	PBH910
P	Unalloyed steel	125-220	200-250	200-250		300-350			
	Low-alloyed steel	220-280	180-220	180-220		260-320			
	High-alloy steel	280-380	160-210	150-210		250-300			350-750
M	Stainless steel - Ferritic/martensitic	200-330		160-230	160-230				
	Stainless steel - Austenitic	200-330		150-200	155-210				
	Stainless steel - Austenitic-ferretic (Duplex)	230-260		130-180	140-190				
K	Malleable cast iron	130-230	220-280	235-290	235-290				700-1000
	Grey cast iron	180-245	150-250	220-265	220-265				500-850
	Nodular cast iron	160-250	120-200	165-180	165-180				350-500
N	Aluminium alloys	60-130					250-750	550-750	
	Copper and copper alloys	90-110					265-375	650-950	
S	Heat resistant super alloys (Iron base)	200-280	45-60	45-60			45-60		
	Heat resistant super alloys (Nickel base)	250-320	35-55	35-55			35-55		
	Heat resistant super alloys (Cobalt base)	200-320	15-25	15-25			15-25		
	Titanium alloys (400^{or}<1050[MPa])	-	40-100	40-100			40-100		
H	Extra hard steel	59 HRC	45-70	45-70		60-90			80-200

AVANCE ET PROFONDEUR DE PASSE RECOMMANDEES RECOMMENDED FEEDS AND DEPTH OF CUT

APPLICATION			EBAUCHE		FINITION	
GEOMETRIE			Fz (mm/teeth)	ap (mm)	Fz (mm/teeth)	ap (mm)
	RD...	07T1MO	0,10 - 0,40	0,25 - 1,50	0,10 - 0,32	0,10 - 0,50
		0702MO	0,13 - 0,40	0,80 - 2,00	0,20 - 0,30	0,18 - 0,30
		1003MOT	0,10 - 0,45	0,75 - 2,00	0,10 - 0,32	0,10 - 0,50
		12T3MOT	0,10 - 0,49	1,00 - 2,50	0,10 - 0,32	0,14 - 0,50
		1604MOT	0,10 - 0,50	1,00 - 3,50	0,10 - 0,32	0,14 - 0,50
		2006MOT	2,00 - 5,00	0,20 - 0,50	-	-
	XD...	040110	0,10 - 0,30	0,10 - 0,20	0,05 - 0,25	0,10 - 0,40
		060210	0,10 - 0,30	0,40 - 0,80	0,10 - 0,30	0,40 - 0,80
		10T310	0,20 - 0,40	0,50 - 1,00	0,10 - 0,30	0,10 - 0,20
	PD...	120420	0,28 - 0,60	2,00 - 5,00	-	-
	APKT	1003...	0,10 - 0,30	1,00 - 9,00	0,10 - 0,20	1,00 - 9,00
		1604...	0,20 - 0,50	1,00 - 15,00	0,10 - 0,30	1,00 - 15,00
	ADKT	1505...	0,20 - 0,50	2,00 - 14,00	-	-
	WNMW	1207-SP	0,50 - 2,00	0,50 - 2,00	-	-
	WPRX	10 12 16 20	-	-	0,05 - 0,15	0,10 - 0,40
	WPRP	10 12 16 20	-	-	0,05 - 0,15	0,10 - 0,40
	WPV / WPB	8 10 12 16 20	-	-	0,05 - 0,15	0,10 - 0,40
	WPZ	8 10 12	-	-	0,10 - 0,15	0,10 - 0,40
		16 20	-	-	0,15 - 0,30	0,30 - 1,00
	SPKW / SPKT	130510	0,50 - 2,50	0,50 - 2,50	-	-
		08T308	0,30 - 2,00	0,50 - 1,50	-	-
	WNHU	04T310	-	-	0,15 - 0,30	0,10 - 0,30
	WNKU	060410	-	-	0,20 - 0,50	0,20 - 0,50
	SEHT	13T3	-	-	0,70 - 1,70	0,20 - 10,00
	OFKR / OFKN	070405	0,15 - 0,40	1,00 - 4,00	0,15 - 0,40	1,00 - 4,00
	VCGT	1103...FN-AL	0,10 - 0,50	0,10 - 5,00	0,10 - 0,50	0,10 - 5,00
		2205...FN-AL	0,10 - 0,50	0,10 - 5,00	0,10 - 0,50	0,10 - 5,00

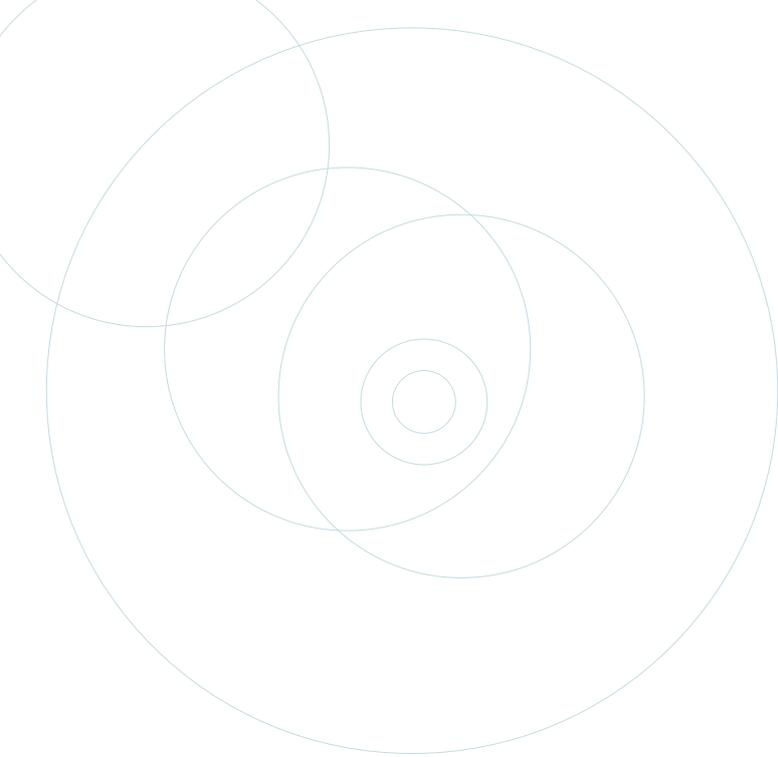

STEMATOOLS
QUALITY TOOLS FOR PROFESSIONALS

Chaussée de Wavre 362
1390 Grez-Doiceau
Belgique

T. + 32 (0)2 361 25 80
F. + 32 (0)2 360 11 22
info@stematools.be

www.stematools.com

